



soulful lighting

nava®

# index

11



globe

13



globe I

15



globe table

17



globe floor

19



globe wall

21



globe wall I

23



jules

25



jules I

27



jules II

29



jules III

30



jules table

31



jules floor

33



jules wall

35



comb

37

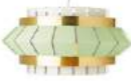

comb I

39



comb floor

41



comb wall

43



loop

45



loop I

47



loop II

49



loop table

51



loop table I

53



loop table II

55



loop wall

57



magnolia

59



magnolia I

61



magnolia II

63



magnolia III

65



magnolia table

67



magnolia floor

69



magnolia wall

71



carousel

73



carousel I

75



carousel wall

78



expand

79



revolution

81



circus

83



circus I

85



circus II

87



circus III

89



circus table

91



circus floor

93



circus wall

95



up

97



up I

99



up table

101



up floor

102



extrude

103



extrude table

105



extrude table I

107



extrude floor

109

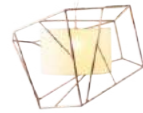

star

111



star I

113



star II

115



star III

117



star table

119



star floor

121



star wall

123



new spider

125



new spider I

127



new spider II

129



new spider table

131



new spider floor

133



new spider wall



Lighting contributes tremendously to how one experiences spaces, as it is able to, very efficiently, influence the perception and appearance of what surrounds us; to shift sensations and feelings.

*Utu soulful lighting* is the response to an urge to create lighting solutions which enrich spaces with individuality and meaning. Born from the creative hub *Mambo unlimited ideas*, *Utu* presents a versatile lighting collection, with pieces holding quite distinct characters and for different uses, including suspension, table, floor and wall lamps in a wide range of possible finishings.

We produce unique, quality products – while our work draws inspiration from every corner of the globe, it nevertheless remains rooted in local knowledge and crafts expertise. *Utu's* growing international presence reflects our approach and reputation: we offer unique products and a dedicated team ready to collaborate with professionals worldwide.

**We welcome you to our world, where creativity, quality and reliability are the guidelines.**

A iluminação contribui tremendamente para a vivência dos ambientes, sendo capaz de influenciar a percepção e aparência do que nos rodeia; de proporcionar diferentes sensações e experiências.

A *Utu soulful lighting* responde ao desejo de criar peças de iluminação que enriqueçam os espaços com individualidade e significado. Nascida no seio da *Mambo unlimited ideas*, a *Utu* apresenta uma ampla coleção com diferentes conceitos e soluções funcionais, disponíveis numa interessante variedade de acabamentos.

Produzimos produtos únicos e de qualidade – recolhendo inspiração em vários cantos do planeta, não deixamos nunca de valorizar as nossas raízes de conhecimento e as nossas competências de fabrico. A crescente presença dos produtos *Utu* no mercado internacional reflecte a nossa abordagem e reputação: temos para oferecer produtos únicos e uma equipa pronta para colaborar com profissionais de todo o mundo.

**Bemvindo ao nosso universo, onde a criatividade, qualidade e confiança são as directrizes.**



— Unique pieces made with traditional techniques appeal to us. Our collection is born from the traditional crafts that have been perfected by Portuguese craftsmen: the work of lacquered metals and noble metals such as brass and copper and the work of glass, both with a rich tradition in Portugal. All of our products are carefully made one by one, in a production balanced between state of the art processes and handmade details.

— Sentimos que peças únicas, feitas através de técnicas tradicionais são mais apelativas. As nossas coleções nascem a partir dos ofícios tradicionais que têm sido aperfeiçoados por artesãos portugueses: o trabalho dos metais lacados e de metais nobres como o latão e o cobre e o trabalho do vidro, ambos com rica tradição em Portugal. Todos os nossos produtos são cuidadosamente produzidos um a um, numa produção equilibrada entre os processos industriais mais avançados e detalhes de produção artesanal.



Embracing our crafts heritage, while up to date with the innovations and creativity developments around the world, *Utu soulful lighting* develops contemporary pieces with traditional Portuguese materials and techniques. This aspect is a constant in our creative process and produces high quality products: we mix what we do best – edgy creativity and experienced craftsman production. —

Abraçando a sua herança artesanal, enquanto acompanha a inovação e evolução criativas ao redor do mundo, a *Utu soulful lighting* desenvolve peças contemporâneas com base em materiais e técnicas tradicionais portuguesas. Este aspeto é uma constante em nosso processo criativo e resulta em produtos de alta qualidade: combinamos o que fazemos melhor – criatividade inovadora e produção artesanal experiente. —

**collection**





— BEAUTIFULLY CRAFTED WITH EXTREME CARE, GLOBE SUSPENSION LAMP SETS A HIGH STANDARD OF BALANCE, SOPHISTICATION AND CHARACTER. GENEROUS YET SMOOTH LIGHTING FILTERS DOWN FROM THE OPAL GLASS ELEMENTS, WHILE THE POLISHED BRASS, COPPER OR BRONZE STRUCTURE IS TAILORED TO PERFECTION. —

# globe

suspension lamp



1

ø: 100 cm / 39"  
 h: 50 cm / 20"  
**structure:** lacquered metal, polished or brushed metal  
**globe:** glass  
 hallogen bulb 10 x max. G9 / 40W

**estrutura:** metal lacado, metal polido ou escovado  
**globo:** vidro  
 lâmpada de halogéneo 10 x máx. G9 / 40W



2

3



# globe I

suspension lamp



13 |

1

Ø: 80 cm / 32"  
h: 50 cm / 20"  
**structure:** lacquered metal, polished or brushed metal  
**globe:** glass  
hallogen bulb 8 x max. G9 / 40W

**estrutura:** metal lacado, metal polido ou escovado  
**globo:** vidro  
lâmpada de halogéneo 8 x máx. G9 / 40W



2

3



# globe table

table lamp



1

h: 59 cm / 23"  
w: 42 cm / 17"  
d: 20 cm / 8"

**structure:** lacquered metal, polished or brushed metal

**globe:** glass

**base:** lacquered metal, polished or brushed metal, marble  
hallogen bulb 1 x max. G9 / 60W

**estrutura:** metal lacado, metais polidos ou escovado

**globo:** vidro

**base:** metal lacado, metal polido ou escovado, mármore  
lâmpada de halogéneo 1 x máx. G9 / 60W



2



3





# globe floor

floor lamp



1

h: 169 cm / 67"  
 w: 93 cm / 37"  
 d: 15 cm / 6"  
**structure:** lacquered metal, polished or brushed metal  
**globe:** glass  
**base:** lacquered metal, polished or brushed metal, marble  
 hallogen bulb 3 x max. G9 / 60W

**estrutura:** metal lacado, metal polido ou escovado  
**globo:** vidro  
**base:** metal lacado, metal polido ou escovado, mármore  
 lâmpada de halogéneo 3 x máx. G9 / 60W



2

3





# globe wall

wall lamp



1

h: 40 cm / 16"  
w: 15 cm / 6"  
d: 27 cm / 11"  
**structure:** lacquered metal, polished or brushed metal  
**globe:** glass  
hallogen bulb 1 x max. G9 / 60W 

**estrutura:** metal lacado, metal polido ou escovado  
**globo:** vidro  
lâmpada de halogéneo 1 x máx. G9 / 60W 



2



3



# globe wall I

wall lamp



1

h: 41 cm / 16"  
w: 36 cm / 14"  
d: 33 cm / 13"  
**structure:** lacquered metal, polished or brushed metal  
**globe:** glass  
hallogen bulb 2 x max. G9 / 60W

**estrutura:** metal lacado, metal polido ou escovado  
**globo:** vidro  
lâmpada de halogéneo 2 x máx. G9 / 60W



2

3

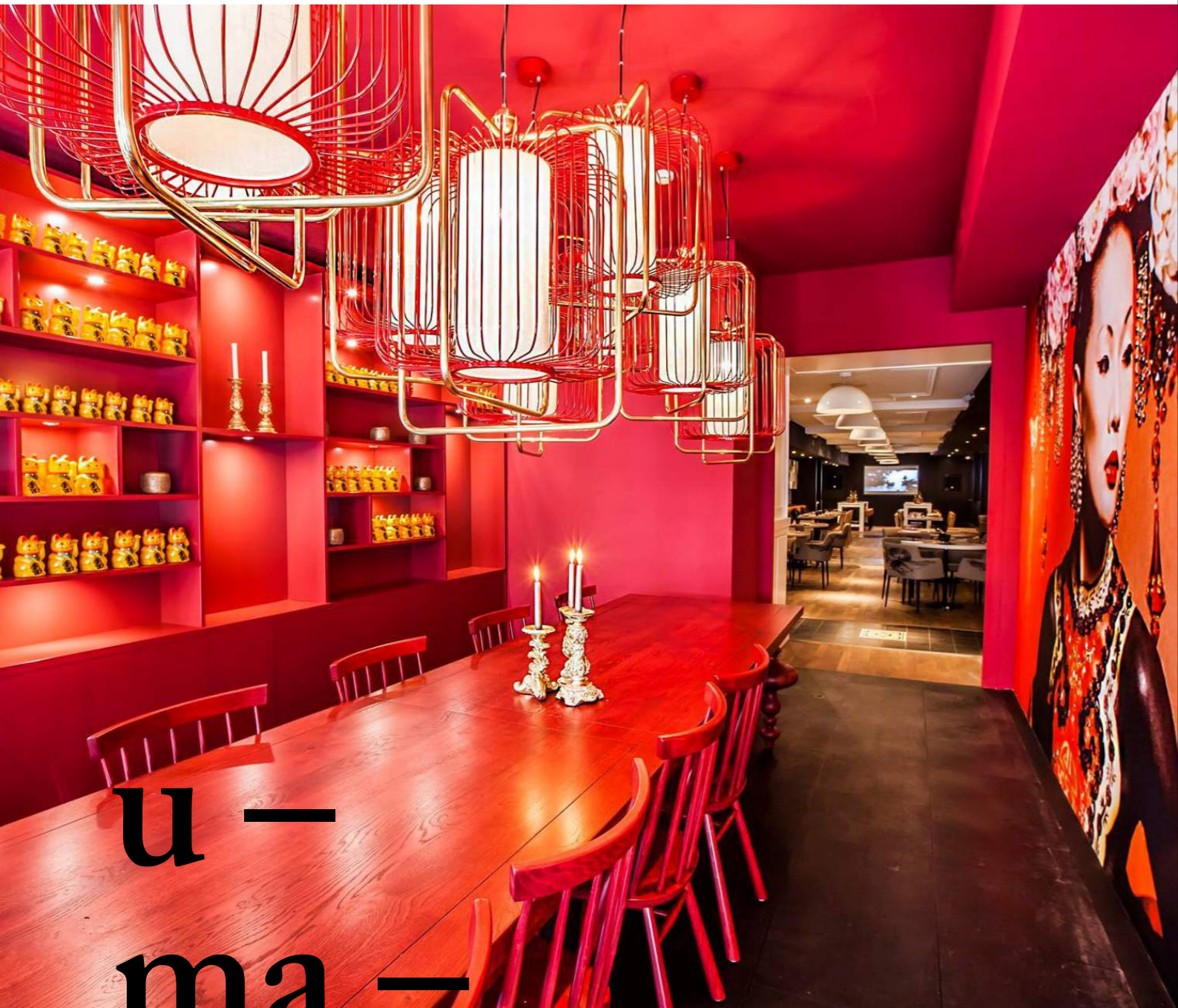

u -  
ma -  
mi

UMAMI RESTAURANT,  
THE NETHERLANDS

# jules

suspension lamp



1

ø: 73 cm / 25"  
h: 72 cm / 28"  
**structure:** lacquered metal, polished or brushed metal  
**tubes:** polished or brushed metal  
**abat-jour:** linen  
energy saving bulb E27/1x23W 

**estrutura:** metal lacado, metal polido ou escovado  
**tubos:** metal polido ou escovado  
**abat-jour:** linho  
lâmpada económica E27/1x23W 

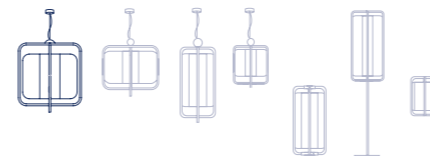

2



3

# jules I

suspension lamp





With their clean, vertical lines, Jules lamps are the image of sophistication.



1

∅: 63 cm / 25"  
h: 57 cm / 22"

**structure:** lacquered metal, polished or brushed metal  
**tubes:** polished or brushed metal  
**abat-jour:** linen  
energy saving bulb E27/1x23W 

**estrutura:** metal lacado, metal polido ou escovado  
**tubos:** metal polido ou escovado  
**abat-jour:** linho  
lâmpada económica E27/1x23W 

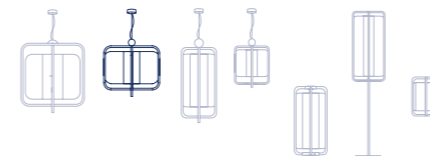

2



3



REFAHN HOTEL,  
TURKEY

# jules II

suspension lamp



1

ø: 30 cm / 12"  
h: 64 cm / 25"  
**structure:** lacquered metal, polished or brushed metal  
**tubes:** polished or brushed metal  
**abat-jour:** linen  
energy saving bulb E27/1x23W 

**estrutura:** metal lacado, metal polido ou escovado  
**tubos:** metal polido ou escovado  
**abat-jour:** linho  
lâmpada económica E27/1x23W 

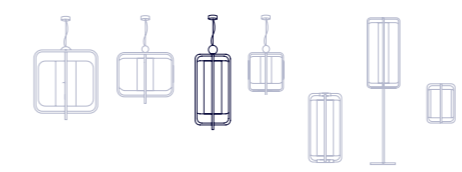

2



3

— Balanced layers and intersecting elements. —



## jules III

suspension lamp



29 |

1

Ø: 38 cm / 15"  
h: 44 cm / 17"

**structure:** lacquered metal, polished or brushed metal

**tubes:** polished or brushed metal

**abat-jour:** linen

energy saving bulb E27/1x23W 

**estrutura:** metal lacado, metal polido ou escovado

**tubos:** metal polido ou escovado

**abat-jour:** linho

lâmpada económica E27/1x23W 

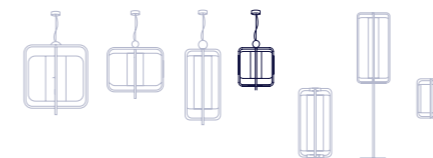

2



3

# jules table

table lamp



1

∅: 30 cm / 12"  
h: 63 cm / 25"  
**structure:** lacquered metal, polished or brushed metal  
**tubes:** polished or brushed metal  
**abat-jour:** linen  
energy saving bulbs E27/1x23W

**estrutura:** metal lacado, metal polido ou escovado  
**tubos:** metal polido ou escovado  
**abat-jour:** linho  
lâmpada económica E27/1x23W

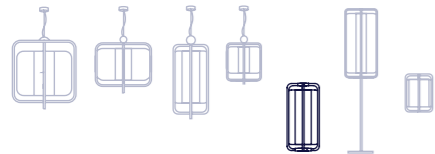

2



3

# jules floor

floor lamp



1

∅: 38 cm / 15"  
h: 177 cm / 38"  
**structure:** lacquered metal, polished or brushed metal  
**tubes:** polished or brushed metal  
**abat-jour:** linen  
energy saving bulb E27/1x23W

**estrutura:** metal lacado, metal polido ou escovado  
**tubos:** metal polido ou escovado  
**abat-jour:** linho  
lâmpada económica E27/1x23W

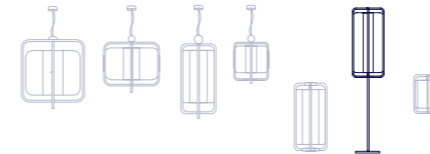

2



3





# jules wall

wall lamp

— Symmetrical lines in a smooth edged square shape, Jules wall lamp presents an original concept, with two layers which relate to each other. Framed within a structure of polished brass or copper hand shaped tubes, floats a lacquered mesh-like structure, that may be colourful or discreet, setting the mood of the ambience. —



1

h: 40 cm / 16"  
w: 40 cm / 16"  
d: 23 cm / 9"

**estrutura:** lacquered metal, polished or brushed metal

**tubes:** polished or brushed metal

**abat-jour:** linen

energy saving bulb E14/1x20W 

**estrutura:** metal lacado, metal polido ou escovado

**tubos:** metal polido ou escovado

**abat-jour:** linho

lâmpada económica E14/1x20W 

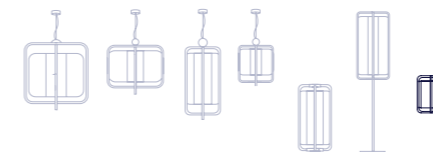

2



3

# comb

suspension lamp



SOCO RESTAURANT,  
BARCELONA



1

ø: 74 cm / 29"  
h: 60 cm / 24"  
**structure:** lacquered metal  
**rings:** lacquered metal, polished brass or copper  
energy saving bulb E27/1x23W ☉

**estrutura:** metal lacado  
**anéis:** metal lacado, latão ou cobre polidos  
lâmpada económica E27/1x23W ☉

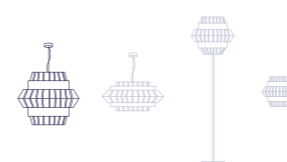

2

3



CHAPEAU NOIR RESTAURANT,  
FRANCE

# comb I

suspension lamp



37 |

1

Ø: 75 cm / 30"  
h: 35 cm / 14"  
**structure:** lacquered metal  
**rings:** lacquered metal, polished brass or copper  
energy saving bulb E27/1x23W Ⓞ

**estrutura:** metal lacado, latão ou cobre polidos  
**anéis:** metal lacado, latão ou cobre polidos  
lâmpada económica E27/1x23W Ⓞ

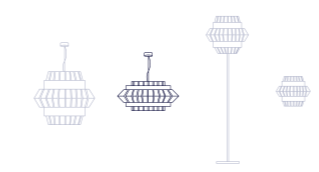

2

3

# comb floor

floor lamp



— Comb floor emerges in a strong color palette, setting a bold atmosphere. —

— COMB LAMPS ARE ELEGANT IN THEIR BALANCED SHAPES, WITH SUBTLE GLANCES OF LIGHT SHOWING BETWEEN ITS CAREFULLY SHAPED GEOMETRIC PLATES. —



1

Ø: 54 cm / 21"  
h: 175 cm / 69"  
**structure:** lacquered metal  
**rings:** lacquered metal, polished brass or copper  
energy saving bulb E27/1x23W ◐

**estrutura:** metal lacado, latão ou cobre polidos  
**anéis:** metal lacado, latão ou cobre polidos  
lâmpada económica E27/1x23W ◐

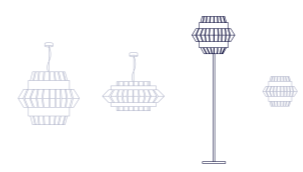

2



3



JAVA CAFÉ,  
FRANCE

# comb wall

wall lamp



41 |

1

h: 34 cm / 13"  
w: 37 cm / 15"  
d: 13 cm / 5"  
**structure:** lacquered metal  
**rings:** lacquered metal, polished brass or copper  
energy saving bulb E14/1x15W 

**estrutura:** metal lacado  
**anéis:** metal lacado, latão ou cobre polidos  
lâmpada económica E14/1x15W 

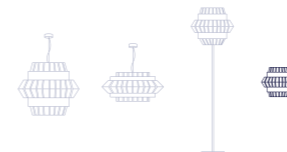

2



3



# loop

suspension lamp



43 |

1

h: 77 cm / 30"  
w: 55 cm / 22"  
d: 25 cm / 10"  
**structure:** lacquered metal, polished or brushed metal  
**globe:** glass  
hallogen bulb 1 x max. G9 / 60W

**estrutura:** metal lacado, metal polido ou escovado  
**globo:** vidro  
lâmpada de halogéneo 1 x máx. G9 / 60W



2

3



# loop I

suspension lamp

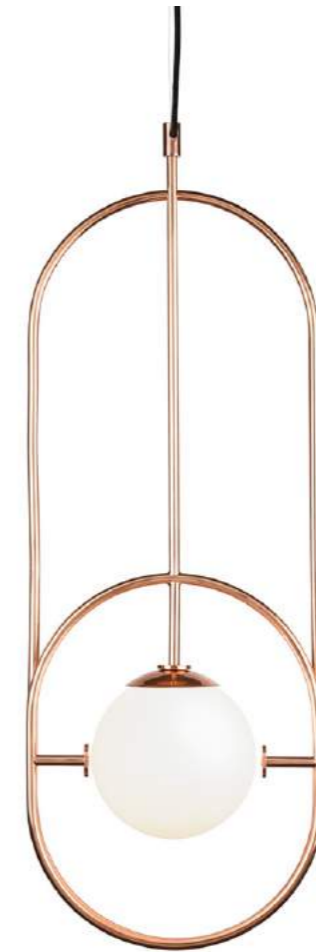

1

h: 74 cm / 29"  
 w: 26 cm / 10"  
 d: 15 cm / 6"  
**structure:** lacquered metal, polished or brushed metal  
**globe:** glass  
 hallogen bulb 1 x max. G9 / 60W

**estrutura:** metal lacado, metal polido ou escovado  
**globo:** vidro  
 lâmpada de halogéneo 1 x máx. G9 / 60W



2

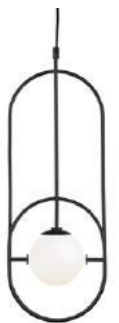

3



# loop II

suspension lamp



1

h: 47 cm / 18"  
w: 31 cm / 12"  
d: 15 cm / 6"  
**structure:** lacquered metal, polished or brushed metal  
**globe:** glass  
hallogen bulb 1 x max. G9 / 60W

**estrutura:** metal lacado, metal polido ou escovado  
**globo:** vidro  
lâmpada de halogéneo 1 x máx. G9 / 60W

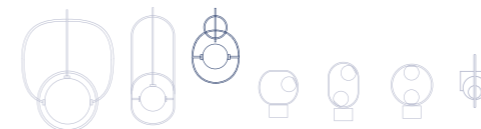

2

3





— Balance,  
sophistication and  
character. —

# loop table

table lamp



1

h: 38 cm / 15"  
w: 36 cm / 14"  
d: 15 cm / 6"  
**structure:** lacquered metal, polished or brushed metal  
**globe:** glass  
**base:** lacquered metal, polished or brushed metal, marble  
hallogen bulb 1 x max. G9 / 60W

**estrutura:** metal lacado, metal polido ou escovado  
**globo:** vidro  
**base:** metal lacado, metal polido ou escovado, mármore  
lâmpada de halogéneo 1 x máx. G9 / 60W



2



3

# loop table I

table lamp

— Contemporary yet with a vintage twist, this table lamp's curved structure kindly wraps two opal glass globes. Even shapes, top and bottom presence, as if the lamp's elements were in a continuous time loop and were brought to pause, to preserve the moment of perfection that gives shape to Loop table. —



1

h: 50 cm / 20"  
w: 30 cm / 12"  
d: 15 cm / 6"  
**structure:** lacquered metal, polished or brushed metal  
**globe:** glass  
**base:** lacquered metal, polished or brushed metal, marble  
hallogen bulb 2 x max. G9 / 60W ☞

**estrutura:** metal lacado, metal polido ou escovado  
**globo:** vidro  
**base:** metal lacado, metal polido ou escovado, mármore  
lâmpada de halogéneo 2 x máx. G9 / 60W ☞

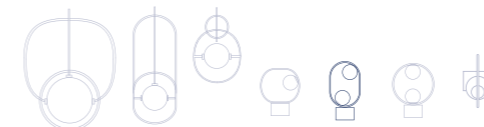

2



3



# loop table II

table lamp



1

53 |

h: 47 cm / 19"  
w: 43 cm / 17"  
d: 15 cm / 6"

**structure:** lacquered metal, polished or brushed metal

**globe:** glass

**base:** lacquered metal, polished or brushed metal, marble  
hallogen bulb 2 x max. G9 / 60W

**estrutura:** metal lacado, metal polido ou escovado

**globo:** vidro

**base:** metal lacado, metal polido ou escovado, mármore  
lâmpada de halogéneo 2 x máx. G9 / 60W



2

3





# loop wall

wall lamp



1

h: 27 cm / 11"  
w: 15 cm / 6"  
d: 30 cm / 12"  
**structure:** lacquered metal, polished or brushed metal  
**globe:** glass  
hallogen bulb 1 x max. G9 / 60W 

**estrutura:** metal lacado, metal polido ou escovado  
**globo:** vidro  
lâmpada de halogéneo 1 x máx. G9 / 60W 

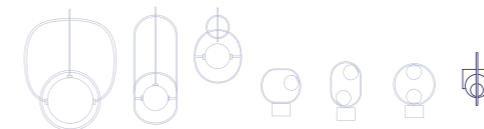

2



3

# magnolia

suspension lamp

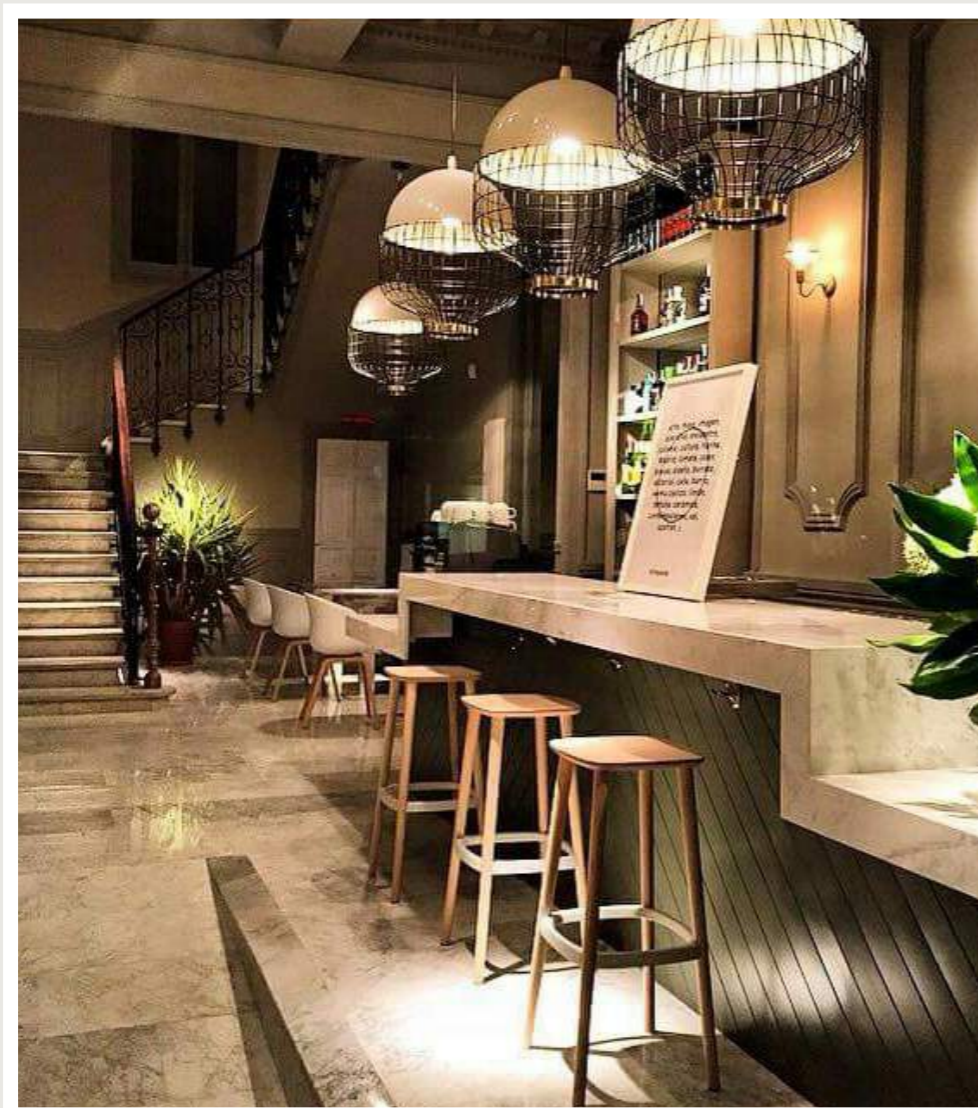

EL IMPARCIAL RESTAURANT,  
SPAIN

— With three different structural elements which colors can be customised, this lamp can be transformed by choosing different color combinations, suiting every project's specific needs. Here, the elegant shapes of Magnolia I interact gracefully with the architectural and furniture elements. —



1

Ø: 65 cm / 26"  
h: 68 cm / 27"

**top:** lacquered metal

**structure:** lacquered metal, polished or brushed metal

**ring:** lacquered metal, polished or brushed metal  
energy saving bulb E27/1x23W ◯

**topo:** metal lacado

**estrutura:** metal lacado, metal polido ou escovado

**anel:** metal lacado, metal polido ou escovado

lâmpada económica E27/1x23W ◯

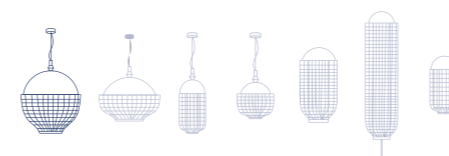

2



3

BELKA RESTAURANT,  
RUSSIA



# magnolia I

suspension lamp



1

Ø: 65 cm / 26"  
h: 47 cm / 19"

**top:** lacquered metal

**structure:** lacquered metal, polished or brushed metal

**ring:** lacquered metal, polished or brushed metal  
energy saving bulb E27/1x23W ◯

**topo:** metal lacado

**estrutura:** metal lacado, metal polido ou escovado

**anel:** metal lacado, metal polido ou escovado  
lâmpada económica E27/1x23W ◯

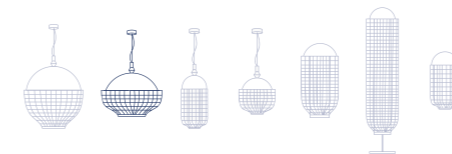

2



3



# magnolia II

suspension lamp



1

ø: 27 cm / 11"

h: 59 cm / 23"

**top:** lacquered metal, polished or brushed metal

**structure:** lacquered metal, polished or brushed metal

**ring:** lacquered metal, polished or brushed metal

**abat-jour:** cotton

energy saving bulb E27/1x23W 

**topo:** metal lacado, metal polido ou escovado

**estrutura:** metal lacado, metal polido ou escovado

**anel:** metal lacado, metal polido ou escovado

**abat-jour:** algodão

lâmpada económica E27/1x23W 

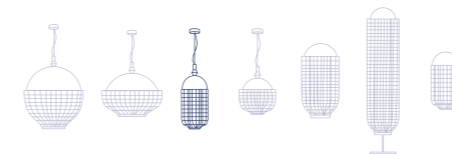

2



3



— MAGNOLIA BRINGS CHARM AND IRREVERENCE TO ANY SPACE. —



# magnolia III

suspension lamp



63 |

1

ø: 31 cm / 12"

h: 42 cm / 17"

**top:** lacquered metal, polished or brushed metal

**structure:** lacquered metal, polished or brushed metal

**ring:** lacquered metal, polished or brushed metal

**abat-jour:** cotton

energy saving bulb E27/1x20W 

**topo:** metal lacado, metal polido ou escovado

**estrutura:** metal lacado, metal polido ou escovado

**anel:** metal lacado, metal polido ou escovado

**abat-jour:** algodão

lâmpada económica E27/1x20W 

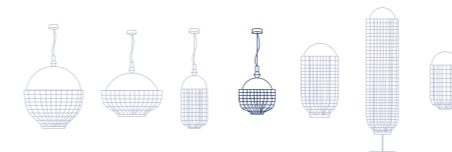

2



3





BELKA RESTAURANT,  
RUSSIA

— THEIR SOFT TOP - MUCH LIKE A  
ROUNDED PETAL - SITS UPON A  
STRUCTURED, GRIDDED BOTTOM.  
THESE CONTRASTING HALVES MAKE  
UP FOR A BALANCED, DELIGHTFUL  
FAMILY OF LAMPS.

Magnolia  
lamps are  
expansive  
and full. —



CASA DECOR MADRID,  
SPAIN

## magnolia table

table lamp



1

Ø: 32 cm / 13"  
h: 63 cm / 25"  
**top:** lacquered metal, polished or brushed metal  
**structure:** lacquered metal, polished or brushed metal  
**abat-jour:** cotton  
energy saving bulb E27/1x15W 

**topo:** metal lacado, metal polido ou escovado  
**estrutura:** metal lacado, metal polido ou escovado  
**abat-jour:** algodão  
lâmpada económica E27/1x15W 

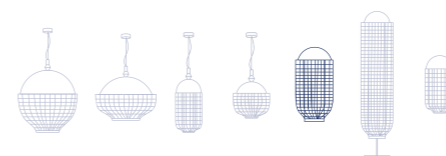

2



3

# magnolia floor

floor lamp



— FRESH AND SAVOURY DETAILS  
LIGHTING UP THE ROOM. —



1

ø: 37 cm / 15"  
h: 170 cm / 67"  
**topo:** lacquered metal, polished or brushed metal  
**estrutura:** lacquered metal, polished or brushed metal  
**abat-jour:** cotton  
energy saving bulb E27/2x23W 

**topo:** metal lacado, metal polido ou escovado  
**estrutura:** metal lacado, metal polido ou escovado  
**abat-jour:** algodão  
lâmpada económica E27/2x23W 

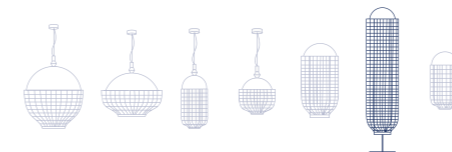

2



3





# magnolia wall

wall lamp



1

h: 56 cm / 22"  
w: 30 cm / 12"  
d: 13 cm / 5"  
**top:** lacquered metal, polished or brushed metal  
**structure:** lacquered metal, polished or brushed metal  
**abat-jour:** cotton  
energy saving bulb E14/1x20W 

**topo:** metal lacado, metal polido ou escovado  
**estrutura:** metal lacado, metal polido ou escovado  
**abat-jour:** algodão  
lâmpada económica E14/1x20W 

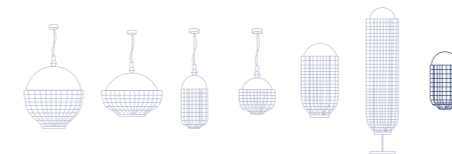

2



3

# carousel

suspension lamp



1

**5 arms 5 braços**    **3 arms 3 braços**  
ø: 110 cm / 43"    ø: 89 cm / 35"  
h: 40 cm / 16"    h: 40 cm / 16"

**structure:** lacquered metal  
**abat-jours:** cotton  
energy saving bulb E27 / 3 or 5 x 23W

**estrutura:** metal lacado  
**abat-jours:** algodão  
lâmpada económica E27 / 3 or 5 x 23W

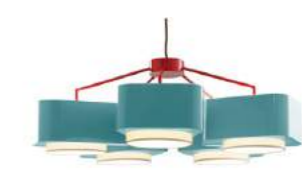
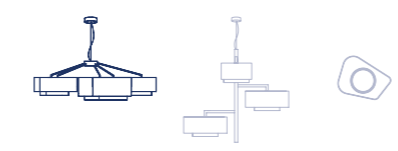

2



3

# carousel I

suspension lamp



1

Ø: 97 cm / 38"  
h: 86 cm / 34"  
**structure:** lacquered metal  
**abat-jours:** cotton  
energy saving bulb E27 / 3 x 23W 

**estrutura:** metal lacado  
**abat-jours:** algodão  
lâmpada económica E27 / 3 x 23W 

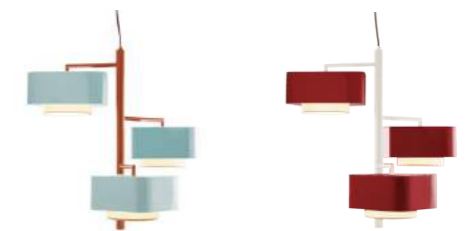
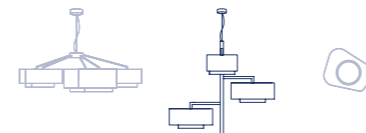

2

3

CAROUSEL LAMPS ARE VIBRANT AND UNUSUAL. INSPIRED BY THE JOY OF RIDING A CAROUSEL, CAROUSEL LAMPS LOOK LIKE THEY COULD START SPINNING AROUND. WHEN THE DESIRE IS TO BRIGHTEN UP ANY SPACE WITH UNIQUE PIECES, CAROUSEL LAMPS ARE THE RIGHT CHOICE.



SKORO VESNA RESTAURANT,  
RUSSIA

# carousel wall

wall lamp



1

h: 30 cm / 12"  
w: 40 cm / 16"  
d: 18 cm / 7"  
**cup:** lacquered metal  
**abat-jour:** cotton  
energy saving bulb E27 / 1 x 20W 

**copo:** metal lacado  
**abat-jour:** algodão  
lâmpada económica E27 / 1 x 20W 



2



3



# expand

suspension lamp



1

∅: 50 cm / 20"  
h: 70 cm / 28"  
**structure:** lacquered metal, polished or brushed metal  
energy saving bulbs E27/1x23W ◐

**estrutura:** metal lacado, metal polido ou escovado  
lâmpada económica E27/1x23W ◐



2



3



# revolution

suspension lamp



1

∅: 55 cm / 22"  
h: 70 cm / 28"  
**structure:** lacquered metal, polished or brushed metal  
energy saving bulb E27/1x23W ◐

**estrutura:** metal lacado, metal polido ou escovado  
lâmpada económica E27/1x23W ◐



2



3





LE BELMONT RESTAURANT  
FRANCE

# circus

suspension lamp



1

ø: 56 cm / 22"  
h: 73 cm / 29"  
**structure:** lacquered metal, polished or oxidized brass  
**abat-jour:** cotton  
energy saving bulb E27/5x23W 

**estrutura:** metal lacado, latão polido ou oxidado  
**abat-jour:** algodão  
lâmpada económica E27/5x23W 

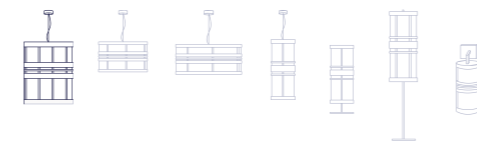

2



3

— Rhythm and elegance  
in a balanced design with  
round and linear shapes. —



# circus I

suspension lamp



83 |

1

∅: 56 cm / 22"  
h: 38 cm / 15"  
**structure:** lacquered metal, polished or oxidized brass  
**abat-jour:** cotton  
energy saving bulb E27/5x23W 

**estrutura:** metal lacado, latão polido ou oxidado  
**abat-jour:** algodão  
lâmpada económica E27/5x23W 



2



3



# circus II

suspension lamp



— CIRCUS II, A PLUS ON LIGHTING AND SOPHISTICATION. —



LE BERRY RESTAURANT,  
FRANCE

ø: 65 cm / 26"  
h: 34 cm / 13"  
**structure:** lacquered metal, polished or oxidized brass  
**abat-jour:** cotton  
energy saving bulb E27/5x23W 

**estrutura:** metal lacado, latão polido ou oxidado  
**abat-jour:** algodão  
lâmpada económica E27/5x23W 

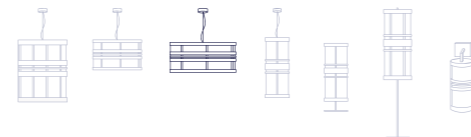

1



2



3



LIGHT AND SHADOW, CURVE  
AND SQUARE, CAREFULLY  
BALANCED.

ESV DIGITAL OFFICES,  
FRANCE

# circus III

suspension lamp



1

∅: 38 cm / 15"  
h: 66 cm / 26"

**structure:** lacquered metal, polished or oxidized brass

**abat-jour:** cotton  
energy saving bulb E27/1x20W 

**estrutura:** metal lacado, latão polido ou oxidado

**abat-jour:** algodão  
lâmpada económica E27/1x20W 

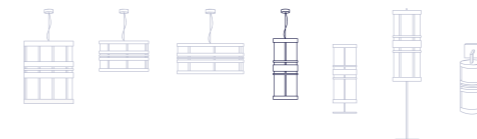

2



3



— EXTREMELY BALANCED AND CAREFULLY HANDMADE, CIRCUS LAMP HAS A STRONG CLASSY FEELING. —





# circus table

table lamp



1

ø: 30 cm / 12"  
 h: 76 cm / 30"  
**structure:** lacquered metal, polished or oxidized brass  
**abat-jour:** cotton  
 energy saving bulb E27/1x15W 

**estrutura:** metal lacado, latão polido ou oxidado  
**abat-jour:** algodão  
 lâmpada económica E27/1x15W 

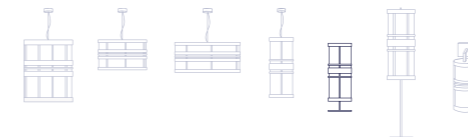

2



3

— Round and sophisticated, Circus lamps are bold and mature in their shapes.



ECLECTIC IQ OFFICES,  
THE NETHERLANDS

— Circus floor lamp is an uncommon lamp: a column of light with its big illuminated area. It distributes light in a big area, providing soft, comfortable lighting that spreads throughout the space. At this modern and eclectic open space in Amsterdam, Netherlands, house of Eclectic IQ offices, it shines with its elegant presence. —

## circus floor

floor lamp



1

ø: 35 cm / 14"  
h: 170 cm / 67"

**structure:** lacquered metal, polished or oxidized brass

**abat-jour:** cotton  
energy saving bulb E27/6x15W 

**estrutura:** metal lacado, latão polido ou oxidado

**abat-jour:** algodão  
lâmpada económica E27/6x15W 

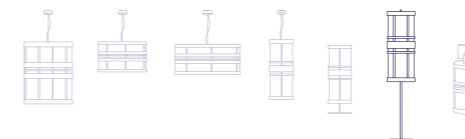

2



3



LOVE CERAMIC TILES,  
PORTUGAL

# circus wall

wall lamp



1

h: 62 cm / 24"  
w: 27 cm / 11"  
d: 30 cm / 12"  
**structure:** lacquered metal, polished or oxidized brass  
**abat-jour:** cotton  
energy saving bulb E14/1x20W 

**estrutura:** metal lacado, latão polido ou oxidado  
**abat-jour:** algodão  
lâmpada económica E14/1x20W 

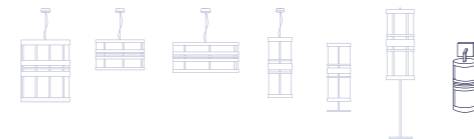

2



3



FIREEYE OFFICES,  
THE NETHERLANDS

# up

suspension lamp



1

ø: 55 cm / 22"  
h: 72 cm / 28"

**structure:** lacquered metal, polished or brushed metal

**ring:** lacquered metal, polished or brushed metal

**abat-jour:** cotton  
energy saving bulb E27/1x23W 

**estrutura:** metal lacado, metal polido ou escovado

**anel:** metal lacado, metal polido ou escovado

**abat-jour:** algodão  
lâmpada económica E27/1x23W 

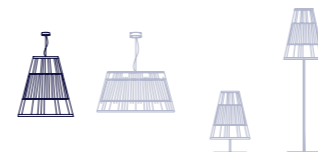

2



3



Up lamps  
combine classic  
and original  
styles.



**up I**  
suspension lamp



1

∅: 68 cm / 27"  
h: 39 cm / 15"  
**structure:** lacquered metal, polished or brushed metal  
**ring:** lacquered metal, polished or brushed metal  
**abat-jour:** cotton  
energy saving bulb E27/1x23W 

**estrutura:** metal lacado, metal polido ou escovado  
**anel:** metal lacado, metal polido ou escovado  
**abat-jour:** algodão  
lâmpada económica E27/1x23W 

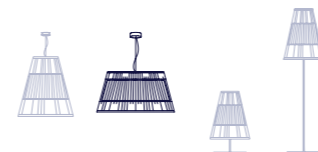

2



3

— Long lines in bright tones. Up lamps are a subtle yet bold choice, with their colorful intersecting lines and eye catching dimensions.



— Bright tones, enhanced by delicate materials, embellish the settings where Up table lamp emerges as an important character, playing first role in defining the contemporary look on these both spaces. A rhythmic lacquered metal mesh makes these pieces surface textured and the light results soft and comfortable filtered by the cotton lampshade. —

PRIVATE HOUSES,  
PORTUGAL

## up table

table lamp



1

∅: 44 cm / 17"  
h: 72 cm / 28"

**structure:** lacquered metal, polished or brushed metal

**ring:** lacquered metal, polished or brushed metal

**abat-jour:** cotton

energy saving bulb E27/1x15W 

**estrutura:** metal lacado, metal polido ou escovado

**anel:** metal lacado, metal polido ou escovado

**abat-jour:** algodão

lâmpada económica E27/1x15W 

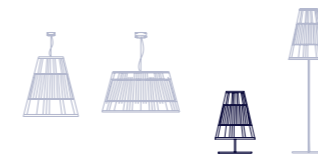

2



3

— Vibrant tones in a white surrounding, bold colour  
Up floor irradiates joy and irreverence. —



SLEEP N' ATOCHA HOTEL,  
SPAIN

— Featured at Sleep n'Atocha Hotel in Madrid, Spain, Up floor in mint color stands deliciously colourful in a palette of vibrant colourful pieces over a white canvas. Subtlety and audacity holding hands in a bold combination that transpires good mood and a touch of humor. —

## up floor

floor lamp

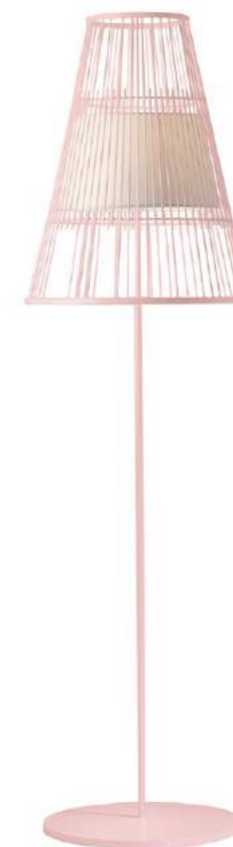

1

Ø: 47 cm / 19"  
h: 170 cm / 67"  
**structure:** lacquered metal, polished or brushed metal  
**ring:** lacquered metal, polished or brushed metal  
**abat-jour:** cotton  
energy saving bulb E27/1x23W

**estrutura:** metal lacado, metal polido ou escovado  
**anel:** metal lacado, metal polido ou escovado  
**abat-jour:** algodão  
lâmpada económica E27/1x23W

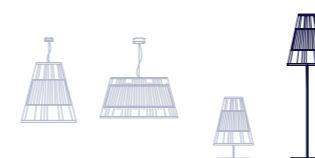

2



3

# extrude

suspension lamp



1

∅: 60 cm / 24"  
h: 70 cm / 28"  
**structure:** lacquered metal  
**abat-jour:** cotton  
energy saving bulb E27/1x23W

**estrutura:** metal lacado  
**abat-jour:** algodão  
lâmpada económica E27/1x23W

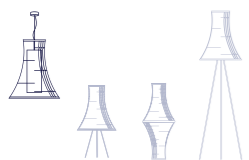

2



3

# extrude table

table lamp



1

∅: 34 cm / 13"  
h: 70 cm / 28"  
**structure:** lacquered metal, polished or brushed metal  
energy saving bulb E27/1x15W

**estrutura:** metal lacado, metal polido ou escovado  
lâmpada económica E27/1x15W



2



3





# extrude table I

table lamp



1

ø: 14 cm / 13"  
h: 75 cm / 30"

**structure:** lacquered metal, polished or brushed metal  
energy saving bulb E27/1x15W ☞

**estrutura:** metal lacado, metal polido ou escovado  
lâmpada económica E27/1x15W ☞



2



3

# rtl head – – quar ters



## extrude floor

floor lamp



1

ø: 50 cm / 20"  
h: 175 cm / 69"

**structure:** lacquered metal, polished or brushed metal  
energy saving bulb E27/1x23W ☉

**estrutura:** metal lacado, metal polido ou escovado  
lâmpada económica E27/1x23W ☉



2



3



DRAKE & MORGAN AT KING'S CROSS,  
UNITED KINGDOM

# star

suspension lamp



1

ø: 80 cm / 32"  
h: 70 cm / 28"  
**structure:** lacquered metal, polished or brushed metal  
**abat-jour:** linen  
energy saving bulb E27/1x23W 

**estrutura:** metal lacado, metal polido ou escovado  
**abat-jour:** linho  
lâmpada económica E27/1x23W 

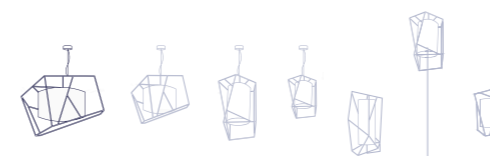

2



3



— Natural textures and a bohemian feeling fill this cosy space.

AT THIS PRIVATE HOUSE, STAR I BRINGS CHARM, ENHANCING THE PURITY OF SHAPES AND NATURE HARVESTED MATERIALS.



PRIVATE HOUSE, FRANCE  
BOH DECORATION & LIFESTYLE  
MIGUEL RAMOS PHOTOGRAPHY

## star I

suspension lamp



111 |

1

ø: 60 cm / 24"  
h: 50 cm / 20"  
**structure:** lacquered metal, polished or brushed metal  
**abat-jour:** linen  
energy saving bulb E27/1x23W 

**estrutura:** metal lacado, metal polido ou escovado  
**abat-jour:** linho  
lâmpada económica E27/1x23W 

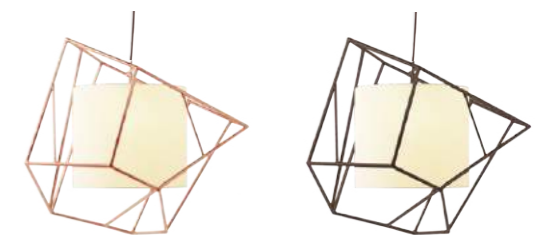
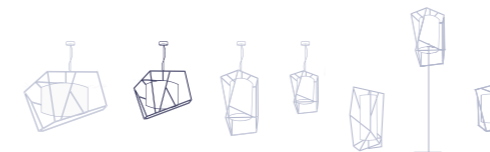

2

3





LE MEETING RESTAURANT,  
FRANCE

# star II

suspension lamp



1

Ø: 45 cm / 18"  
h: 72 cm / 28"  
**structure:** lacquered metal, polished or brushed metal  
**abat-jour:** linen  
energy saving bulb E27/1x23W 

**estrutura:** metal lacado, metal polido ou escovado  
**abat-jour:** linho  
lâmpada económica E27/1x23W 

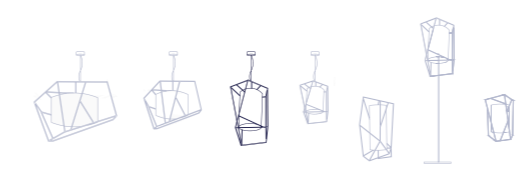

2



3

# star III

suspension lamp

— Star lamps shine specially bright.



— Seducing, Star asymmetrical floating structure, with its rich linen lampshade, is a sculptural piece that brings a touch of poetry to spaces.

The unpredictable geometry gives Star lamp many different facets: from each perspective it is observed, it shows a different shape.



1

∅: 35 cm / 14"  
h: 53 cm / 21"  
**structure:** lacquered metal, polished or brushed metal  
**abat-jour:** linen  
energy saving bulb E27/1x23W

**estrutura:** metal lacado, metal polido ou escovado  
**abat-jour:** linho  
lâmpada económica E27/1x23W

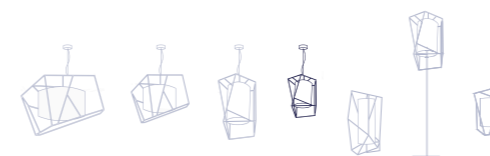

2



3

# star table

table lamp

— Light as made of pure lines, with no standard base, Star table lamp seems light as a feather. While one travels through space and sees it in different perspectives, an everchanging design comes to full evidence. It never looks the same. —



PRIVATE HOUSE,  
PORTUGAL



1

ø: 33 cm / 13"  
h: 72 cm / 28"  
**structure:** lacquered metal, polished or brushed metal  
**abat-jour:** linen  
energy saving bulb E27/1x15W

**estrutura:** metal lacado, metal polido ou escovado  
**abat-jour:** linho  
lâmpada económica E27/1x15W

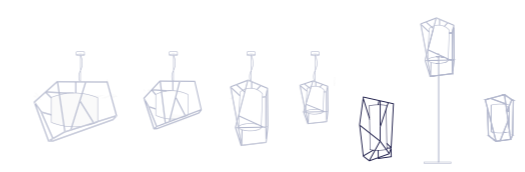

2



3

— Golden  
elegance in a art  
filled room. —



MOONGATA SHOWROOM,  
SPAIN

— AT MOONGATA'S SHOWROOM, IN MADRID, STAR'S CONTEMPORARY DESIGN  
BALANCES THE RETRO FEELING FROM THE FURNITURE. DELICATE, BALANCED  
COLORS BRING TO LIFE AN ELEGANT, CREATIVE SPACE. —

## star floor

floor lamp



1

ø: 45 cm / 18"  
h: 170 cm / 67"  
**structure:** lacquered metal, polished or brushed metal  
**abat-jour:** linen  
energy saving bulb E27/1x23W 

**estrutura:** metal lacado, metal polido ou escovado  
**abat-jour:** linho  
lâmpada económica E27/1x23W 

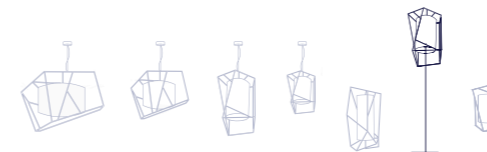

2



3

# star wall

wall lamp





CASA DECOR MADRID,  
SPAIN

STAR WALL LAMP IS THE PERFECT FIT FOR THIS MODERN, SLEEK SPACE. WITH ITS FACETED GOLDEN JEWEL LOOK, BALANCED WITH ITS PURE LINES, STAR WALL LAMP BLENDS IN PERFECTLY WITH THE GEOMETRICAL ELEMENTS IN THIS SPACE.



1

h: 51 cm / 20"  
w: 28 cm / 11"  
d: 20 cm / 8"  
**structure:** lacquered metal, polished or brushed metal  
**abat-jour:** linen  
energy saving bulb E14/1x20W 

**estrutura:** metal lacado, metal polido ou escovado  
**abat-jour:** linho  
lâmpada económica E14/1x20W 

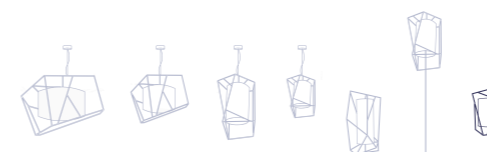

2



3



Playing with shape and transparency,  
with regular and irregular edges.



# new spider

suspension lamp



123 |

1

ø: 70 cm / 28"  
h: 35 cm / 14"  
**structure:** lacquered metal, polished or brushed metal  
**ring:** lacquered metal, polished or brushed metal  
energy saving bulb E27/1x23W Ⓞ

**estrutura:** metal lacado, metal polido ou escovado  
**anel:** metal lacado, metal polido ou escovado  
lâmpada econômica E27/1x23W Ⓞ



2



3



# new spider I

suspension lamp



125 |

1

ø: 52 cm / 20"  
h: 70 cm / 28"

**structure:** lacquered metal, polished or brushed metal  
**ring:** lacquered metal, polished or brushed metal  
energy saving bulb E27/1x23W ◐

**estrutura:** metal lacado, metal polido ou escovado  
**anel:** metal lacado, metal polido ou escovado  
lâmpada económica E27/1x23W ◐



2

3



CORIANDER LEAF RESTAURANT,  
SINGAPORE

# new spider II

suspension lamp



1

ø: 70 cm / 28"  
h: 100 cm / 39"

**structure:** lacquered metal, polished or brushed metal  
**ring:** lacquered metal, polished or brushed metal  
energy saving bulb E27/1x23W ☉

**estrutura:** metal lacado, metal polido ou escovado  
**anel:** metal lacado, metal polido ou escovado  
lâmpada econômica E27/1x23W ☉

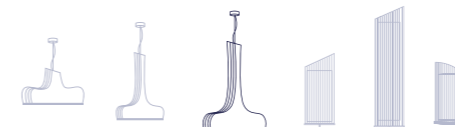

2



3





PRIVATE HOUSE,  
PORTUGAL

# new spider table

table lamp



1

Ø: 24 cm / 9"  
h: 60 cm / 20"  
**structure:** lacquered metal, polished or brushed metal  
**ring:** lacquered metal, polished or brushed metal  
**abat-jour:** cotton  
energy saving bulb E27/1x15W 

**estrutura:** metal lacado, metal polido ou escovado  
**anel:** metal lacado, metal polido ou escovado  
**abat-jour:** algodão  
lâmpada económica E27/1x15W 



2



3



— VELVET-LIKE LIGHTING FOR EXTREME COMFORT WITH A CONTEMPORARY TWIST. —



PRIVATE HOUSE,  
PORTUGAL

## new spider floor

floor lamp



1

ø: 30 cm / 12"  
h: 140 cm / 55"  
**structure:** lacquered metal, polished or brushed metal  
**abat-jour:** cotton  
energy saving bulb E27/2x23W 

**estrutura:** metal lacado, metal polido ou escovado  
**abat-jour:** algodão  
lâmpada económica E27/2x23W 



2

3





MAULU HOTEL,  
RUSSIA

## new spider wall wall lamp



1

h: 50 cm / 20"  
w: 25 cm / 10"  
d: 15 cm / 6"  
**structure:** lacquered metal, polished or brushed metal  
**abat-jour:** cotton  
energy saving bulb E14/1x15W 

**estrutura:** metal lacado, metal polido ou escovado  
**abat-jour:** algodão  
lâmpada económica E14/1x15W 



2



3



**technical  
information**

# suspension lamps

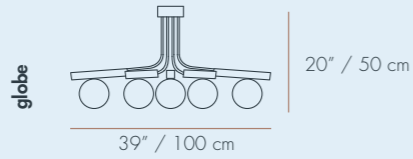

230V / 50Hz  
 10 x max. G9 40W  
 120V / 60Hz  
 10 x max. G9 40W  
 Cable 59" / 1,5m

17,6 lb | 8 kg  
 0,42 m<sup>3</sup>

CE

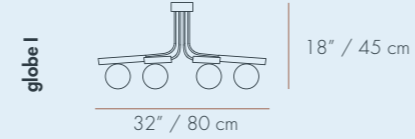

230V / 50Hz  
 8 x max. G9 40W  
 120V / 60Hz  
 8 x max. G9 40W  
 Cable 59" / 1,5m

8,8 lb | 4 kg  
 0,20 m<sup>3</sup>

CE

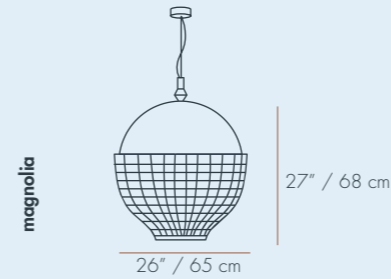

230V / 50Hz  
 E27/1x23W CFL  
 120V / 60Hz  
 E26/1x18W CFL  
 Cable 59" / 1,5m

19 lb | 9 kg  
 0,42 m<sup>3</sup>

CE



230V / 50Hz  
 E27/1x23W CFL  
 120V / 60Hz  
 E26/1x18W CFL  
 Cable 59" / 1,5m

19 lb | 9 kg  
 0,21 m<sup>3</sup>

CE



230V / 50Hz  
 E27/1x23W CFL  
 120V / 60Hz  
 E26/1x18W CFL  
 Cable 59" / 1,5m

13 lb | 6 kg  
 0,09 m<sup>3</sup>

CE

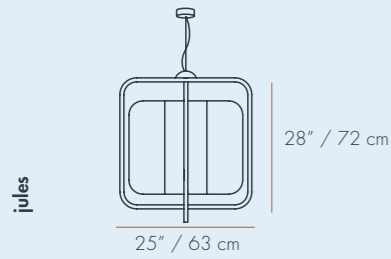

230V / 50Hz  
 E27/1x23W CFL  
 120V / 60Hz  
 E26/1x18W CFL  
 Cable 59" / 1,5m

19 lb | 9 kg  
 0,42 m<sup>3</sup>

CE

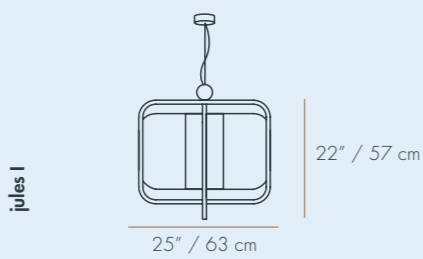

230V / 50Hz  
 E27/1x23W CFL  
 120V / 60Hz  
 E26/1x18W CFL  
 Cable 59" / 1,5m

19 lb | 9 kg  
 0,21 m<sup>3</sup>

CE

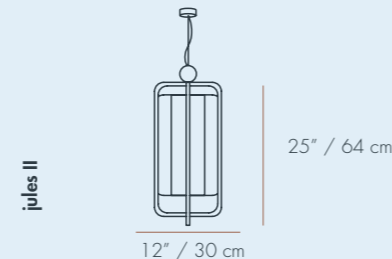

230V / 50Hz  
 E27/1x23W CFL  
 120V / 60Hz  
 E26/1x18W CFL  
 Cable 59" / 1,5m

13 lb | 6 kg  
 0,09 m<sup>3</sup>

CE



230V / 50Hz  
 E27/1x20W CFL  
 120V / 60Hz  
 E26/1x15W CFL  
 Cable 59" / 1,5m

11 lb | 5 kg  
 0,05 m<sup>3</sup>

CE

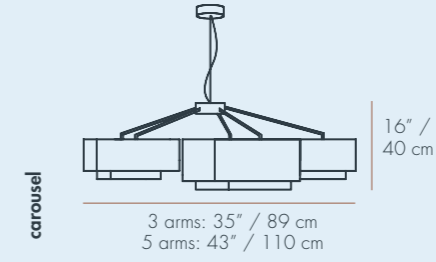

230V / 50Hz  
 E27/3/5 x23W CFL  
 120V / 60Hz  
 E26/3/5x18W CFL  
 Cable 59" / 1,5m

44 lb | 20 kg  
 0,55 m<sup>3</sup>

CE

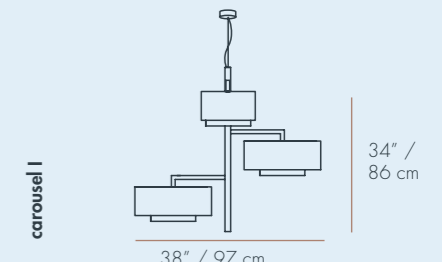

230V / 50Hz  
 E27/3x23W CFL  
 120V / 60Hz  
 E26/3x18W CFL  
 Cable 59" / 1,5m

44 lb | 20 kg  
 0,55 m<sup>3</sup>

CE

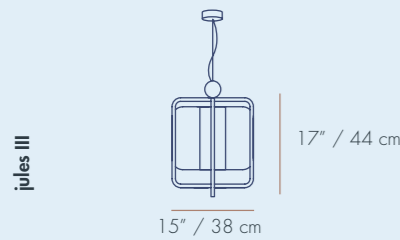

230V / 50Hz  
 E27/1x23W CFL  
 120V / 60Hz  
 E26/1x18W CFL  
 Cable 59" / 1,5m

11 lb | 5 kg  
 0,05 m<sup>3</sup>

CE

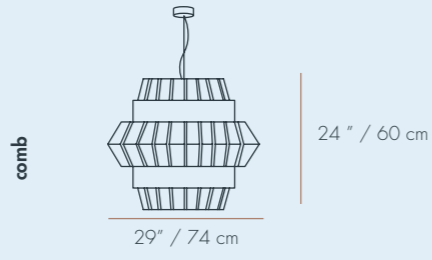

230V / 50Hz  
 E27/1x23W CFL  
 120V / 60Hz  
 E26/1x18W CFL  
 Cable 59" / 1,5m

35 lb | 16 kg  
 0,42 m<sup>3</sup>

CE

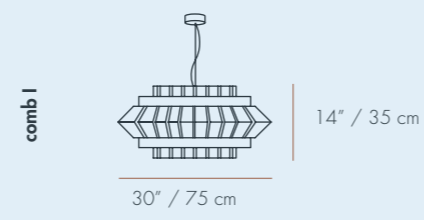

230V / 50Hz  
 E27/1x23W CFL  
 120V / 60Hz  
 E26/1x18W CFL  
 Cable 59" / 1,5m

35 lb | 16 kg  
 0,23 m<sup>3</sup>

CE



230V / 50Hz  
 E27/1x23W CFL  
 120V / 60Hz  
 E26/1x18W CFL  
 Cable 59" / 1,5m

17 lb | 8 kg  
 0,42 m<sup>3</sup>

CE

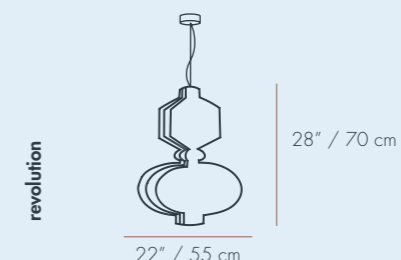

230V / 50Hz  
 E27/1x23W CFL  
 120V / 60Hz  
 E26/1x18W CFL  
 Cable 59" / 1,5m

17 lb | 8 kg  
 0,42 m<sup>3</sup>

CE

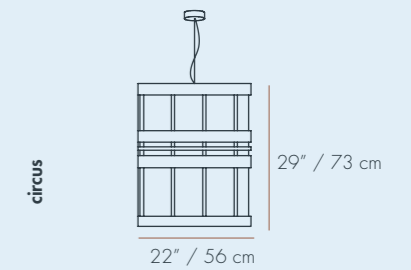

230V / 50Hz  
 E27/5x23W CFL  
 120V / 60Hz  
 E26/5x18W CFL  
 Cable 59" / 1,5m

35 lb | 14 kg  
 0,42 m<sup>3</sup>

CE

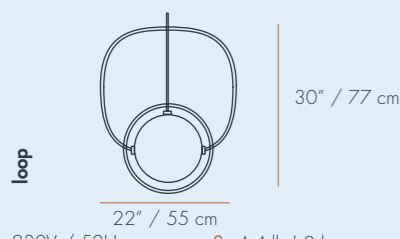

230V / 50Hz  
 1 x max. G9 60W  
 120V / 60Hz  
 1 x max. G9 60W  
 Cable 59" / 1,5m

4,4 lb | 2 kg  
 0,13 m<sup>3</sup>

CE

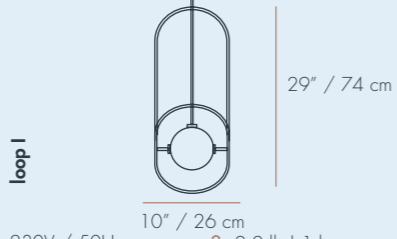

230V / 50Hz  
 1 x max. G9 60W  
 120V / 60Hz  
 1 x max. G9 60W  
 Cable 59" / 1,5m

2,2 lb | 1 kg  
 0,05 m<sup>3</sup>

CE

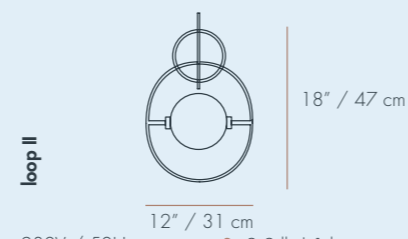

230V / 50Hz  
 1 x max. G9 60W  
 120V / 60Hz  
 1 x max. G9 60W  
 Cable 59" / 1,5m

2,2 lb | 1 kg  
 0,05 m<sup>3</sup>

CE

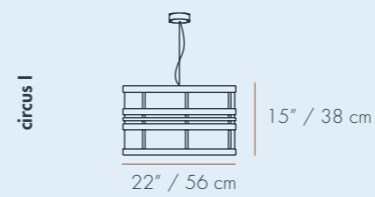

230V / 50Hz  
 E27/5x23W CFL  
 120V / 60Hz  
 E26/5x18W CFL  
 Cable 59" / 1,5m

28 lb | 13 kg  
 0,25 m<sup>3</sup>

CE

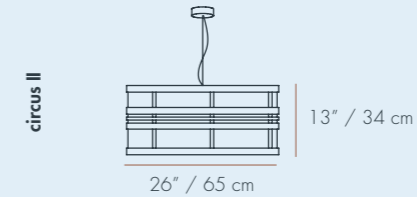

230V / 50Hz  
 E27/5x23W CFL  
 120V / 60Hz  
 E26/5x18W CFL  
 Cable 59" / 1,5m

30 lb | 14 kg  
 0,23 m<sup>3</sup>

CE

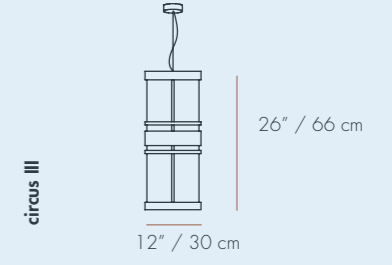

230V / 50Hz  
 E27/1x20W CFL  
 120V / 60Hz  
 E26/1x18W CFL  
 Cable 59" / 1,5m

17 lb | 8 kg  
 0,09 m<sup>3</sup>

CE

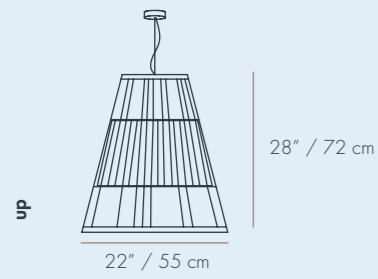

28" / 72 cm

22" / 55 cm

**up**  
230V / 50Hz  
● E27/1x23W CFL 19 lb | 9 kg  
 0,42 m<sup>3</sup>  
120V / 60Hz  
● E26/1x18W CFL  
Cable  
59" / 1,5m

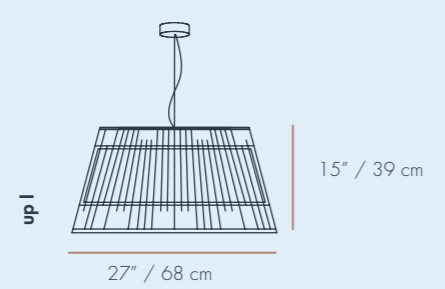

15" / 39 cm

27" / 68 cm

**up I**  
230V / 50Hz  
● E27/1x23W CFL 34 lb | 15 kg  
 0,25 m<sup>3</sup>  
120V / 60Hz  
● E26/1x18W CFL  
Cable  
59" / 1,5m

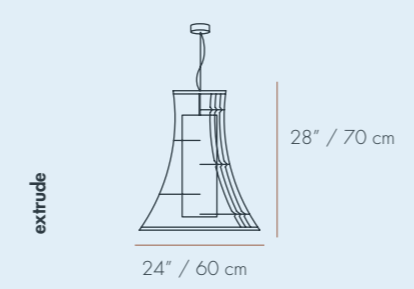

28" / 70 cm

24" / 60 cm

**extrude**  
230V / 50Hz  
● E27/1x23W CFL 19 lb | 9 kg  
 0,42 m<sup>3</sup>  
120V / 60Hz  
● E26/1x18W CFL  
Cable  
59" / 1,5m

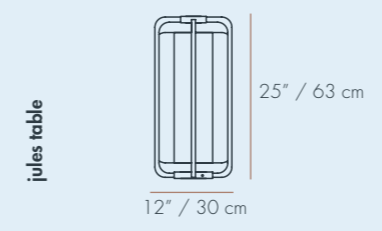

25" / 63 cm

12" / 30 cm

**jules table**  
230V / 50Hz  
● E27/1x15W CFL 17 lb | 8 kg  
 0,09 m<sup>3</sup>  
120V / 60Hz  
● E26/1x13W CFL

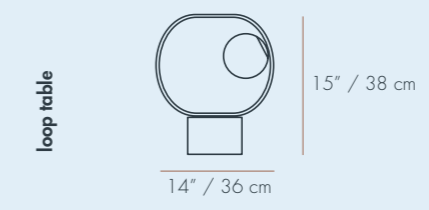

15" / 38 cm

14" / 36 cm

**loop table**  
230V / 50Hz  
● E27/1x15W CFL 4,4 lb | 2 kg  
 0,03 m<sup>3</sup>  
120V / 60Hz  
● E26/1x13W CFL  
1 x max. G9 60W

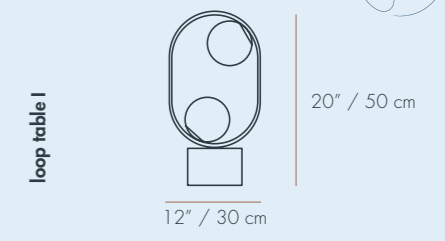

20" / 50 cm

12" / 30 cm

**loop table I**  
230V / 50Hz  
● E27/1x15W CFL 6,6 lb | 3 kg  
 0,03 m<sup>3</sup>  
120V / 60Hz  
● E26/1x13W CFL  
2 x max. G9 40W

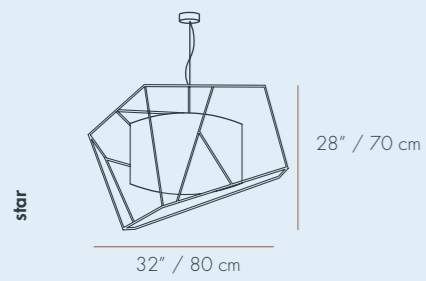

28" / 70 cm

32" / 80 cm

**star**  
230V / 50Hz  
● E27/1x23W CFL 13 lb | 6 kg  
 0,42 m<sup>3</sup>  
120V / 60Hz  
● E26/1x18W CFL  
Cable  
59" / 1,5m

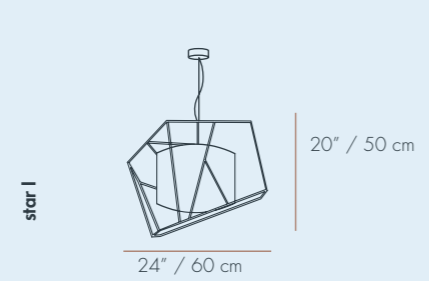

20" / 50 cm

24" / 60 cm

**star I**  
230V / 50Hz  
● E27/1x23W CFL 13 lb | 6 kg  
 0,28 m<sup>3</sup>  
120V / 60Hz  
● E26/1x18W CFL  
Cable  
59" / 1,5m

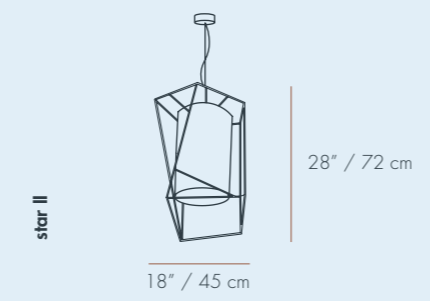

28" / 72 cm

18" / 45 cm

**star II**  
230V / 50Hz  
● E27/1x23W CFL 11 lb | 5 kg  
 0,17 m<sup>3</sup>  
120V / 60Hz  
● E26/1x18W CFL  
Cable  
59" / 1,5m

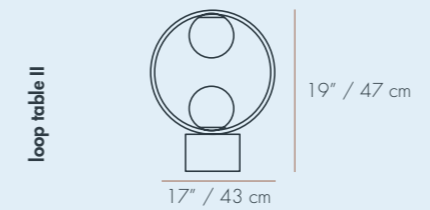

19" / 47 cm

17" / 43 cm

**loop table II**  
230V / 50Hz  
● E27/1x15W CFL 6,6 lb | 3 kg  
 0,04 m<sup>3</sup>  
120V / 60Hz  
● E26/1x13W CFL  
2 x max. G9 40W

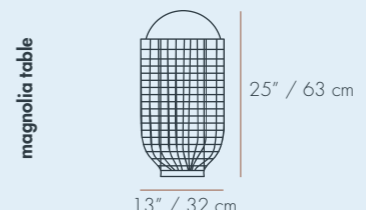

25" / 63 cm

13" / 32 cm

**magnolia table**  
230V / 50Hz  
● E27/1x15W CFL 17 lb | 8 kg  
 0,09 m<sup>3</sup>  
120V / 60Hz  
● E26/1x13W CFL

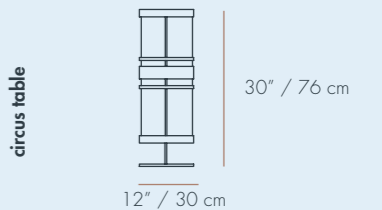

30" / 76 cm

12" / 30 cm

**circus table**  
230V / 50Hz  
● E27/1x15W CFL 17 lb | 8 kg  
 0,09 m<sup>3</sup>  
120V / 60Hz  
● E26/1x13W CFL

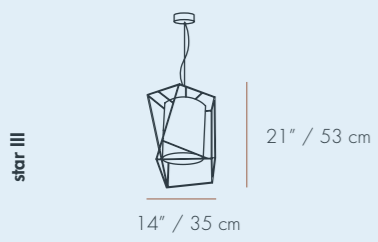

21" / 53 cm

14" / 35 cm

**star III**  
230V / 50Hz  
● E27/1x20W CFL 8 lb | 4 kg  
 0,18 m<sup>3</sup>  
120V / 60Hz  
● E26/1x15W CFL  
Cable  
59" / 1,5m

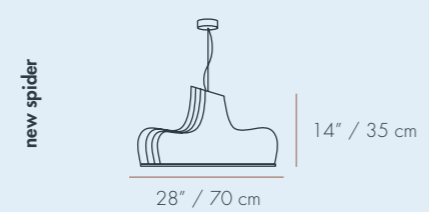

14" / 35 cm

28" / 70 cm

**new spider**  
230V / 50Hz  
● E27/1x23W CFL 17 lb | 8 kg  
 0,26 m<sup>3</sup>  
120V / 60Hz  
● E26/1x18W CFL  
Cable  
59" / 1,5m



28" / 70 cm

20" / 52 cm

**new spider I**  
230V / 50Hz  
● E27/1x23W CFL 19 lb | 9 kg  
 0,42 m<sup>3</sup>  
120V / 60Hz  
● E26/1x18W CFL  
Cable  
59" / 1,5m

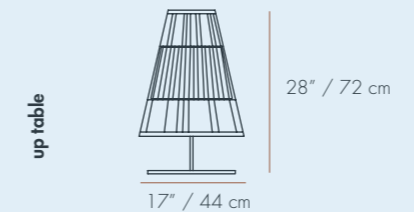

28" / 72 cm

17" / 44 cm

**up table**  
230V / 50Hz  
● E27/1x15W CFL 19 lb | 9 kg  
 0,16 m<sup>3</sup>  
120V / 60Hz  
● E26/1x13W CFL

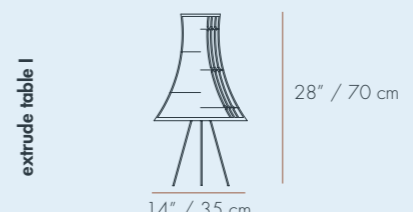

28" / 70 cm

14" / 35 cm

**extrude table I**  
230V / 50Hz  
● E27/1x15W CFL 13 lb | 6 kg  
 0,09 m<sup>3</sup>  
120V / 60Hz  
● E26/1x13W CFL

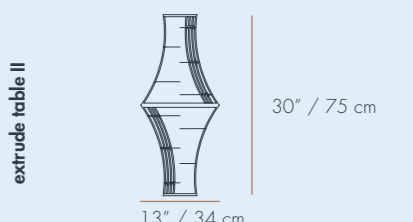

30" / 75 cm

13" / 34 cm

**extrude table II**  
230V / 50Hz  
● E27/1x15W CFL 15 lb | 7 kg  
 0,09 m<sup>3</sup>  
120V / 60Hz  
● E26/1x13W CFL

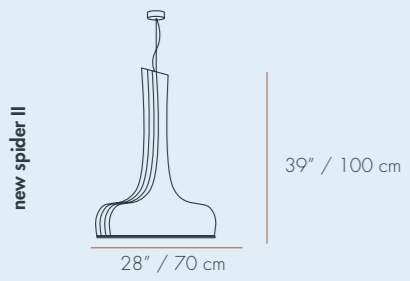

39" / 100 cm

28" / 70 cm

**new spider II**  
230V / 50Hz  
● E27/1x23W CFL 26 lb | 12 kg  
 0,59 m<sup>3</sup>  
120V / 60Hz  
● E26/1x18W CFL  
Cable  
59" / 1,5m

## table lamps



23" / 59 cm

17" / 42 cm

**globe table**  
230V / 50Hz  
● E27/1x15W CFL 6,6 lb | 3 kg  
 0,06 m<sup>3</sup>  
120V / 60Hz  
● E26/1x13W CFL  
1 x max. G9 60W

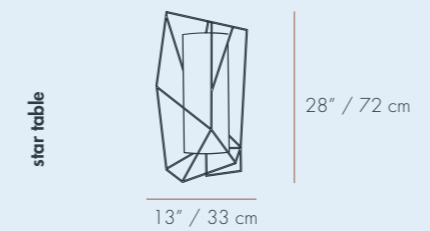

28" / 72 cm

13" / 33 cm

**star table**  
230V / 50Hz  
● E27/1x15W CFL 9 lb | 4 kg  
 0,16 m<sup>3</sup>  
120V / 60Hz  
● E26/1x13W CFL

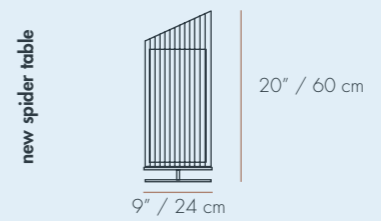

20" / 60 cm

9" / 24 cm

**new spider table**  
230V / 50Hz  
● E27/1x15W CFL 15 lb | 7 kg  
 0,09 m<sup>3</sup>  
120V / 60Hz  
● E26/1x13W CFL



# floor lamps

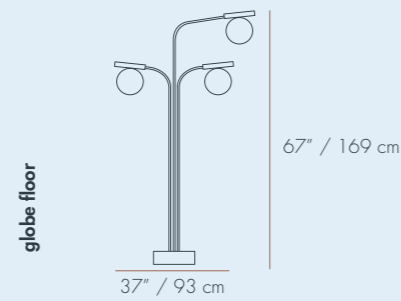

**globe floor**

230V / 50Hz  
● 3 x max. G9 60W 19,85 lb | 9 kg 0,24 m<sup>3</sup>

120V / 60Hz  
● 3 x max. G9 60W

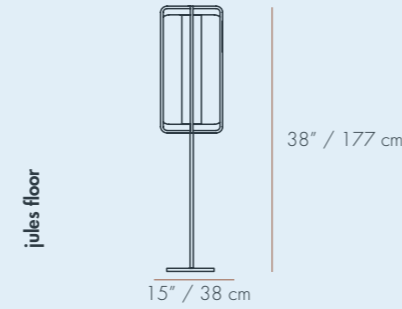

**jules floor**

230V / 50Hz  
● E27/1x23W CFL 26 lb | 12 kg 0,38 m<sup>3</sup>

120V / 60Hz  
● E26/1x18W CFL

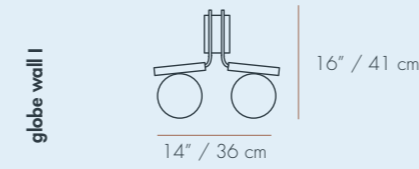

**globe wall I**

230V / 50Hz  
● 2 x max. G9 60W 4,4 lb | 2 kg 0,05 m<sup>3</sup>

120V / 60Hz  
● 2 x max. G9 60W

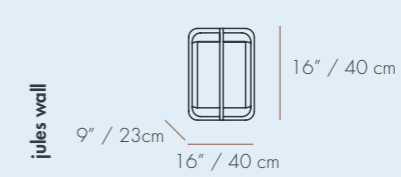

**jules wall**

230V / 50Hz  
● E14/1x20W CFL 8 lb | 4 kg 0,05 m<sup>3</sup>

120V / 60Hz  
● E12/1x15W CFL

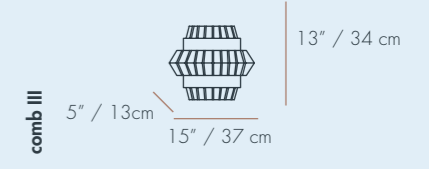

**comb III**

230V / 50Hz  
● E14/1x20W CFL 11 lb | 5 kg 0,05 m<sup>3</sup>

120V / 60Hz  
● E12/1x15W CFL

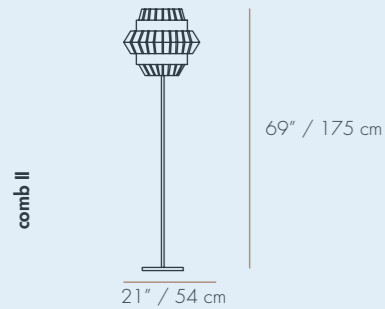

**comb II**

230V / 50Hz  
● E27/1x23W CFL 30 lb | 14 kg 0,65 m<sup>3</sup>

120V / 60Hz  
● E26/1x18W CFL

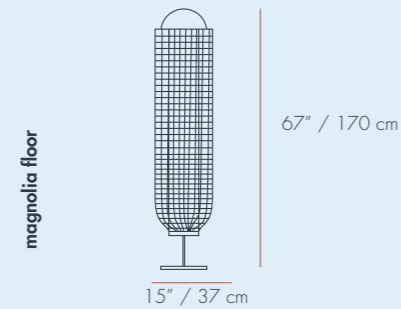

**magnolia floor**

230V / 50Hz  
● E27/2x23W CFL 26 lb | 12 kg 0,38 m<sup>3</sup>

120V / 60Hz  
● E26/2x18W CFL

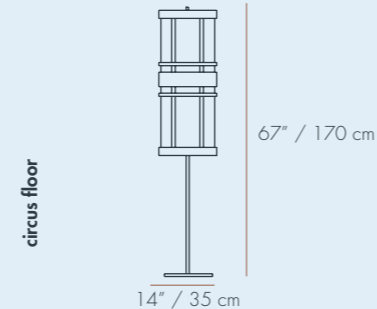

**circus floor**

230V / 50Hz  
● E27/6x15W CFL 37 lb | 17 kg 0,38 m<sup>3</sup>

120V / 60Hz  
● E26/6x13W CFL

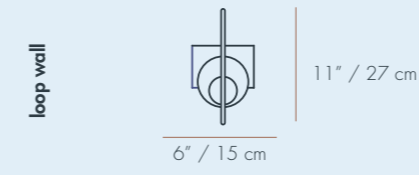

**loop wall**

230V / 50Hz  
● 1 x max. G9 60W 2,2 lb | 1 kg 0,02 m<sup>3</sup>

120V / 60Hz  
● 1 x max. G9 60W

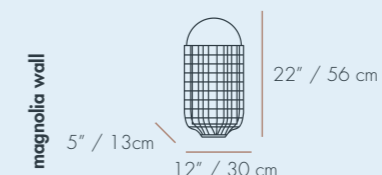

**magnolia wall**

230V / 50Hz  
● E14/1x20W CFL 8 lb | 4 kg 0,05 m<sup>3</sup>

120V / 60Hz  
● E12/1x15W CFL

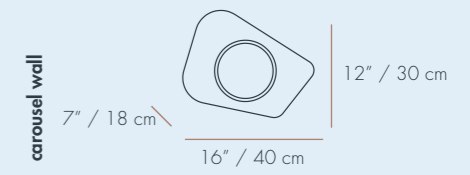

**carousel wall**

230V / 50Hz  
● E27/1x20W CFL 11 lb | 5 kg 0,05 m<sup>3</sup>

120V / 60Hz  
● E26/1x15W CFL

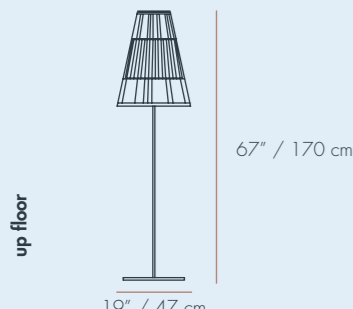

**up floor**

230V / 50Hz  
● E27/1x23W CFL 27 lb | 12 kg 0,49 m<sup>3</sup>

120V / 60Hz  
● E26/1x18W CFL

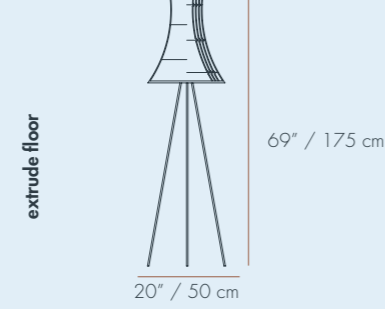

**extrude floor**

230V / 50Hz  
● E27/1x23W CFL 26 lb | 12 kg 0,57 m<sup>3</sup>

120V / 60Hz  
● E26/1x18W CFL

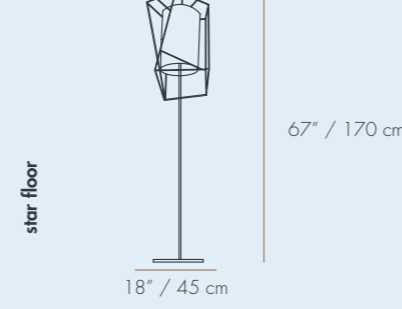

**star floor**

230V / 50Hz  
● E27/1x23W CFL 19 lb | 9 kg 0,38 m<sup>3</sup>

120V / 60Hz  
● E26/1x18W CFL

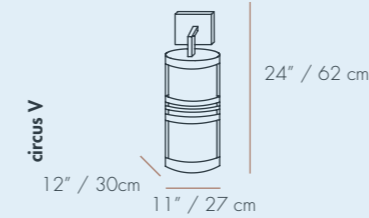

**circus V**

230V / 50Hz  
● E27/1x20W CFL 17 lb | 8 kg 0,09 m<sup>3</sup>

120V / 60Hz  
● E26/1x18W CFL

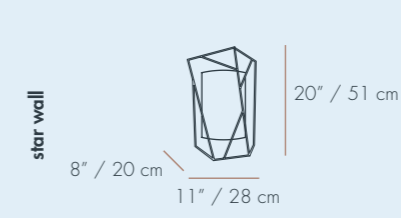

**star wall**

230V / 50Hz  
● E14/1x20W CFL 6 lb | 3 kg 0,05 m<sup>3</sup>

120V / 60Hz  
● E12/1x15W CFL

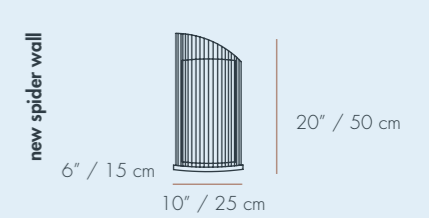

**new spider wall**

230V / 50Hz  
● E14/1x20W CFL 11 lb | 5 kg 0,05 m<sup>3</sup>

120V / 60Hz  
● E12/1x15W CFL

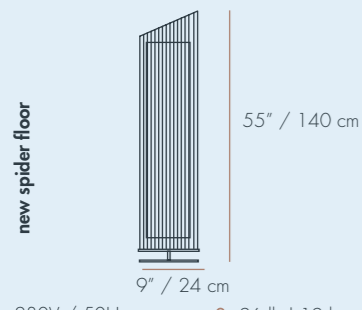

**new spider floor**

230V / 50Hz  
● E27/2x23W CFL 26 lb | 12 kg 0,38 m<sup>3</sup>

120V / 60Hz  
● E26/2x18W CFL

# wall lamps

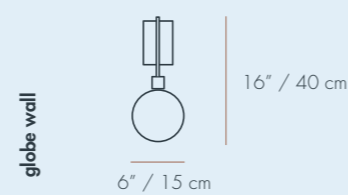

**globe wall**

230V / 50Hz  
● 1 x max. G9 60W 2,2 lb | 1 kg 0,02 m<sup>3</sup>

120V / 60Hz  
● 1 x max. G9 60W

# finishings

## cords fios



## cup copo



## abat-jours



## lacquered metal metal lacado



## polished and brushed metal metal polido e escovado

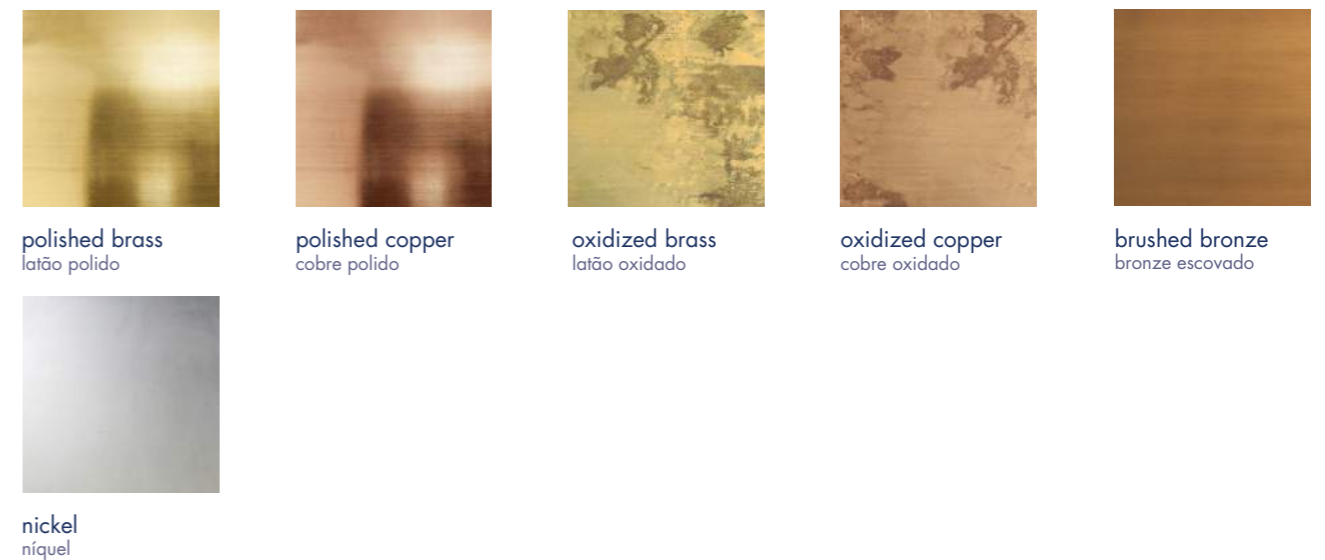

<sup>1</sup> standard for all suspension lamps (except black ones)  
standard para candeeiros de suspensão (excepto pretos)

<sup>2</sup> standard for black suspension lamps  
standard para candeeiros de suspensão pretos

<sup>3</sup> standard for all table and floor lamps  
standard para candeeiros de mesa e chão

<sup>4</sup> available on extra charge  
disponível com custo adicional

\* spotted brown is a painted color  
spotted brown é uma cor pintada

POLISHED AND BRUSHED METAL PIECES:  
this product is handmade; any small stain or roughness  
is a feature of the product, not a defect.

PEÇAS EM METAL POLIDO E ESCOVADO:  
este produto é feito artesanalmente; qualquer pequena  
rugosidade ou mancha é uma característica, não um defeito.

**Sample box available.**  
**Caixa de amostras disponível.**



