

soulful lighting  
**utua**®



# welcome to our world

---

*utu - soulful lighting* is the response to an urge to create lighting solutions that enrich spaces with individuality and meaning.

The experience of spaces and the feeling created has the huge contribute of lighting, as it contributes to its atmosphere and appearance.

Born from the creative hub mambo unlimited ideas, that comprises design talents in a team dedicated to develop new products and ideas, utu soulful lighting is the new brand specifically dedicated to lighting, where this dimension of design is tirelessly explored and developed.

Presenting a wide lighting collection with different concepts and functional solutions which includes suspension, table, floor and wall lamps in a wide range of possible finishings, utu launches as a very versatile and complete brand.

Already mature as being heir of the experience and knowhow acquired while under the mambo unlimited ideas label, utu soulful lighting follows the market call. It builds an individual space in the company scope for the continued growth of the lighting collection, with the same base values but with a soul of its own!

So we welcome you to our world! A world where innovation, creativity, quality and reliability are the guidelines. We produce original top quality products - our work is developed towards global business, with international inspiration, while rooted in our local knowledge and crafts expertise.

The growing presence we conquer in the international market reflects our approach and our reputation: we offer original quality products and a professional team ready to collaborate with professionals worldwide.

*utu - soulful lighting*, light devices with soul in a wide range of finishings: endless possible combinations.







# lighting collection

## INDEX

magnolia .....	4
jules .....	18
comb .....	32
carousel .....	40
star .....	46
up .....	60
circus .....	68
spider .....	82
extrude .....	94
revolution .....	102
expand .....	104
cage .....	106
new spider .....	110



## H10 Duque de Loulé

At H10 Duque de Loulé Hotel in Lisbon, the cosy feeling gets a touch of sophistication with Magnolia lamps.

With three different structural elements which colors can be customized, this lamp can transform itself when it appears in different color combinations, suiting every project specific needs.

### H10 Duque de Loulé

Contemporain Studio project

Portugal

\*design by Cláudia Melo



01



02



03



04

## magnolia

suspension lamp  
 ø: 26 in  
 h: 27 in  
 lacquered metal and optional metal/brass/copper ring (cup only in lacquered metal)  
 ● energy saving bulbs E27 / 1x23W

candeeiro de suspensão  
 ø: 65 cm  
 a: 68 cm  
 metal lacado e aro opcional em metal/latão/cobre (copo apenas em metal lacado)  
 ● lâmpada económica E27 / 1x23W





**Sushita cafe**  
 Madrid in Love project  
 Spain

\*design by Cláudia Melo



01

magnolia

09



## magnolia I

suspension lamp  
 ø: 26 in  
 h: 19 in  
 lacquered metal and optional metal/brass/copper ring (cup only in lacquered metal)  
 ● energy saving bulbs E27 / 1x23W

candeeiro de suspensão  
 ø: 65 cm  
 a: 47 cm  
 metal lacado e aro opcional em metal/latão/cobre (copo apenas em metal lacado)  
 ● lâmpada económica E27 / 1x23W





**Maison du Peuple cafe**  
 Sacré Sacré project  
 Belgium

\*design by Cláudia Melo



01



02



03



04



05

## magnolia II

suspension lamp  
 ø: 11 in  
 h: 23 in  
 cup and structure lacquered metal/brass/copper,  
 optional ring metal/brass/copper and cotton shade  
 ● energy saving bulbs E27 / 1x23W

candeeiro de suspensão  
 ø: 27 cm  
 a: 59 cm  
 copo e estrutura metal lacado/latão/cobre, aro  
 opcional metal/ latão/cobre e abajur de algodão  
 ● lâmpada económica E27 / 1x23W





**Crustó cafe**  
 Madrid in Love project  
 Spain

\*design by Cláudia Melo



01



## magnolia III

suspension lamp  
 ø: 12 in  
 h: 17 in  
 cup and structure lacquered metal/brass/copper,  
 optional ring metal/brass/copper and cotton shade  
 ● energy saving bulbs E27 / 1x20W

candeeiro de suspensão  
 ø: 31 cm  
 a: 42 cm  
 copo e estrutura metal lacado/latão/cobre, aro  
 opcional metal/ latão/cobre e abajur de algodão  
 ● lâmpada económica E27 / 1x20W



\*design by Cláudia Melo



01

## magnolia table

table lamp  
ø: 13 in  
h: 25 in

cup and structure lacquered metal/brass/copper  
and cotton shade  
● energy saving bulbs E27 / 1x15W

candeeiro de mesa  
ø: 32 cm  
a: 63 cm

copo e estrutura metal lacado/latão/cobre  
e abajur de algodão  
● lâmpada económica E27 / 1x15W



02



03



04



05





\*design by Cláudia Melo



01



02

03

04

05

## magnolia floor

floor lamp  
 ø: 15 in  
 h: 67 in  
 cup and structure lacquered metal/brass/copper  
 and cotton shade  
 ● energy saving bulbs E27 / 2x23W

candeeiro de chão  
 ø: 37 cm  
 a: 170 cm  
 copo e estrutura metal lacado/latão/cobre  
 e abajur de algodão  
 ● lâmpada económica E27 / 2x23W





\*design by Cláudia Melo



01



02



03



04



05

## magnolia wall

wall lamp  
w: 12 in  
d: 5 in  
h: 22 in  
cup and structure lacquered metal/brass/copper  
and cotton shade  
● energy saving bulbs E14 / 1x20W

applique  
l: 30 cm  
p: 13 cm  
a: 56 cm  
copo e estrutura metal lacado/latão/cobre  
e abajur de algodão  
● lâmpada económica E14 / 1x20W





\*design by Cláudia Melo

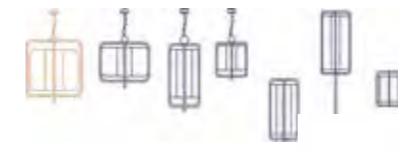

01



02



03



04

## jules

suspension lamp  
ø: 25 in  
h: 28 in  
lacquered metal, brass or copper and  
cotton shade  
● energy saving bulbs E27 / 1x23W

candeeiro de suspensão  
ø: 63 cm  
a: 72 cm  
metal lacado, latão ou cobre e abajur  
de algodão  
● lâmpada económica E27 / 1x23W





\*design by Cláudia Melo



01



02

03

04

04

## jules I

suspension lamp  
 ø: 25 in  
 h: 22 in  
 lacquered metal, brass or copper and  
 cotton shade  
 ● energy saving bulbs E27 / 1x23W

candeeiro de suspensão  
 ø: 63 cm  
 a: 57 cm  
 metal lacado, latão ou cobre e abajur  
 de algodão  
 ● lâmpada económica E27 / 1x23W





**Refahn Hotel**  
Turkey

\*design by Cláudia Melo



01

jules  
**025**

## jules II

suspension lamp  
ø: 12 in  
h: 25 in  
lacquered metal, brass or copper and  
cotton shade  
● energy saving bulbs E27 / 1x23W

candeeiro de suspensão  
ø: 30 cm  
a: 64 cm  
metal lacado, latão ou cobre e abajur  
de algodão  
● lâmpada económica E27 / 1x23W



02

03

04

05





\*design by Cláudia Melo



01



02



03



04

## jules III

suspension lamp  
 ø: 15 in  
 h: 17 in  
 lacquered metal, brass or copper and  
 cotton shade  
 ● energy saving bulbs E27 / 1x23W

candeeiro de suspensão  
 ø: 38 cm  
 a: 44 cm  
 metal lacado, latão ou cobre e abajur  
 de algodão  
 ● lâmpada económica E27 / 1x23W





\*design by Cláudia Melo



01



## jules table

table lamp  
 ø: 12 in  
 h: 25 in  
 lacquered metal, brass or copper and  
 cotton shade  
 ● energy saving bulbs E27 / 1x23W

candeeiro de mesa  
 ø: 30 cm  
 a: 63 cm  
 metal lacado, latão ou cobre e abajur  
 de algodão  
 ● lâmpada económica E27 / 1x23W





\*design by Cláudia Melo



01



02



03



05

## jules floor

floor lamp  
ø: 15 in  
h: 70 in  
lacquered metal, brass or copper and  
cotton shade  
● energy saving bulbs E27 / 1x23W

candeeiro de chão  
ø: 38 cm  
a: 177 cm  
metal lacado, latão ou cobre e abajur  
de algodão  
● lâmpada económica E27 / 1x23W



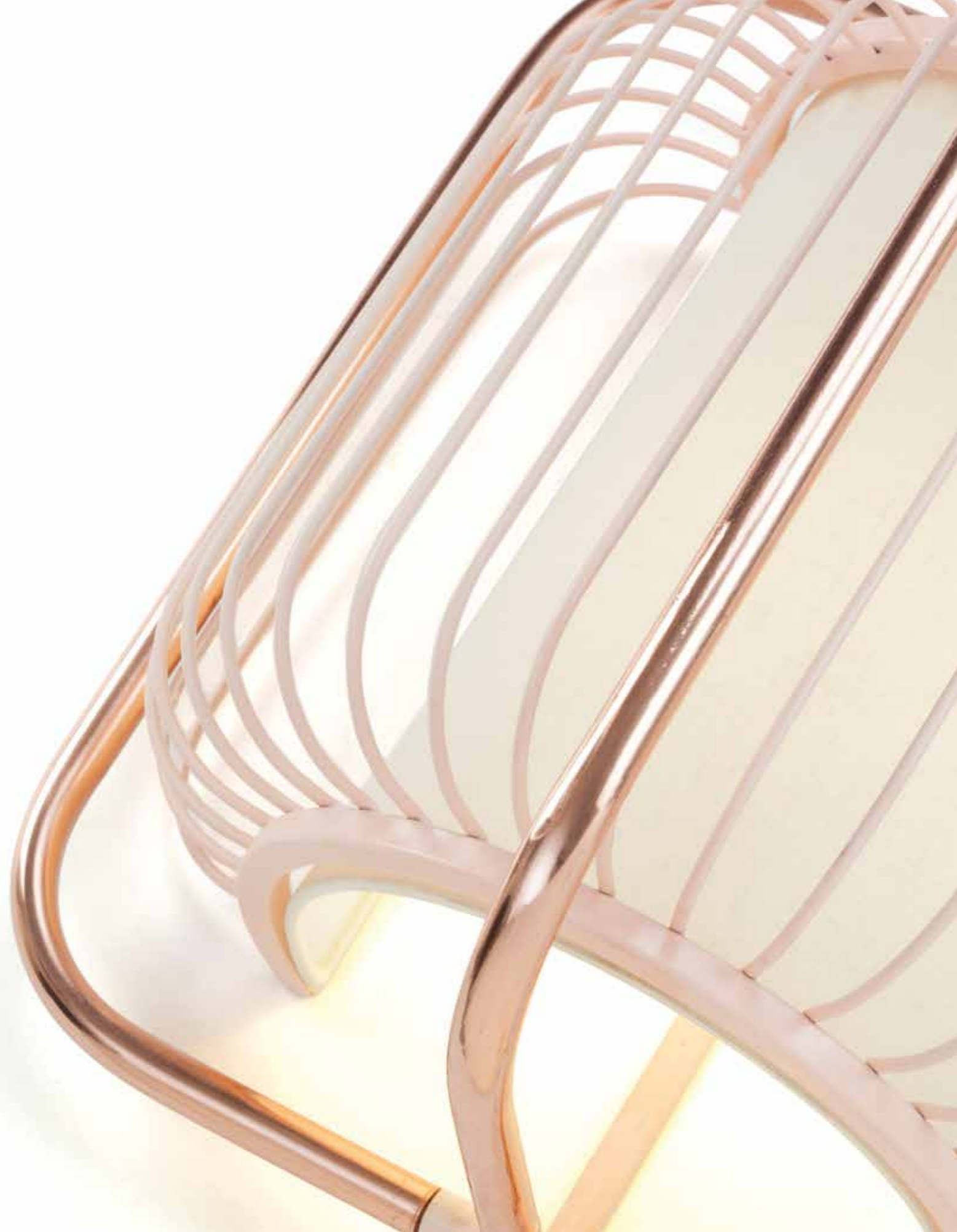

\*design by Cláudia Melo



01

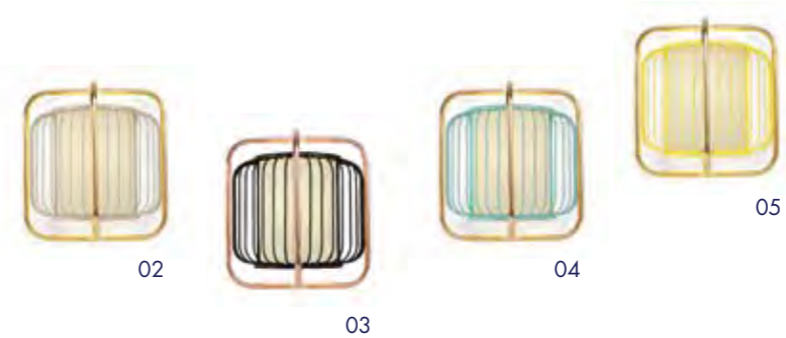

## jules wall

wall lamp  
w: 16 in  
d: 9 in  
h: 16 in  
lacquered metal, brass or copper and  
cotton shade  
● energy saving bulbs E14 / 1x20W

aplique  
l: 40 cm  
p: 23 cm  
a: 40 cm  
metal lacado, latão ou cobre e abajur  
de algodão  
● lâmpada económica E14 / 1x20W



**casa  
mono**



**Casa Mono cafe**

Spain

Comb lamps are elegant in their balanced shapes, glances of light are visible between the carefully shaped geometric plates. The different combinations made possible by the interchangeable finishings are endless.

\*design by Cláudia Melo



01

comb  
**035**

**comb**

suspension lamp  
ø: 29 in  
h: 24 in

lacquered metal and optional metal, brass or copper rings and cotton shade  
● energy saving bulbs E27 / 1x23W

candeeiro de suspensão  
ø: 74 cm  
a: 60 cm

metal lacado e aros em metal, latão ou cobre opcionais  
● lâmpada económica E27 / 1x23W



02



03



04



05





**Chapeau Noir restaurant**  
France

\*design by Cláudia Melo



01

037 comb

## comb I

suspension lamp  
ø: 30 in  
h: 14 in

lacquered metal and optional metal, brass or copper rings and cotton shade  
● energy saving bulbs E27 / 1x23W



02



03



04

candeeiro de suspensão  
ø: 75 cm  
a: 35 cm

metal lacado e aros em metal, latão ou cobre opcionais  
● lâmpada económica E27 / 1x23W



# H10 Duque de Loulé



Floor lamp Comb results as a suspended light jewel, standing on its discreet base, drawing delicate light and shade shapes. Comb floor lamp appears at the banquet room at H10 Duque de Loulé Hotel, bringing a touch of modernity and design to this otherwise classical room.

**H10 Duque de Loulé**  
Contemporain Studio project  
Portugal

\*design by Cláudia Melo



01



02



03



04



05

## comb floor

floor lamp  
ø: 21 in  
h: 69 in  
lacquered metal and optional metal, brass or  
copper rings and cotton shade  
● energy saving bulbs E27 / 1x23W

candeeiro de chão  
ø: 54 cm  
a: 175 cm  
metal lacado e aros em metal, latão ou cobre  
opcionais  
● lâmpada económica E27 / 1x23W





\*design by Cláudia Melo

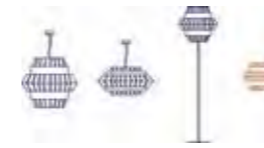

01



02



03



04

## comb wall

wall lamp  
w: 15 in  
d: 7 in  
h: 13 in

lacquered metal and optional metal, brass or copper rings and cotton shade  
● energy saving bulbs E14 / 1x15W

applique  
l: 37 cm  
p: 19 cm  
a: 34 cm

metal lacado e aros em metal, latão ou cobre opcionais  
● lâmpada económica E14 / 1x15W





**Pryanosti & Radosti Restaurant**  
MEGRE INTERIORS project  
Russia

\*design by Cláudia Melo

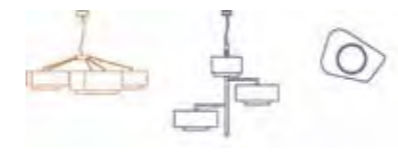

01

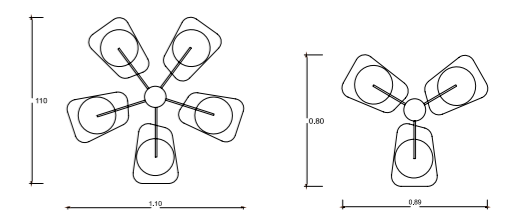

## carousel

suspension lamp  
ø: 43 or 35 in  
h: 16 in

lacquered metal and 5/3 cotton shades  
energy saving bulbs E27 / 5 or 3x23W



03



02



04

candeeiro de suspensão  
ø: 110 or 89 cm  
a: 40 cm

metal lacado e 5/3 abajures de algodão  
lâmpada económica E27 / 5 ou 3x23W



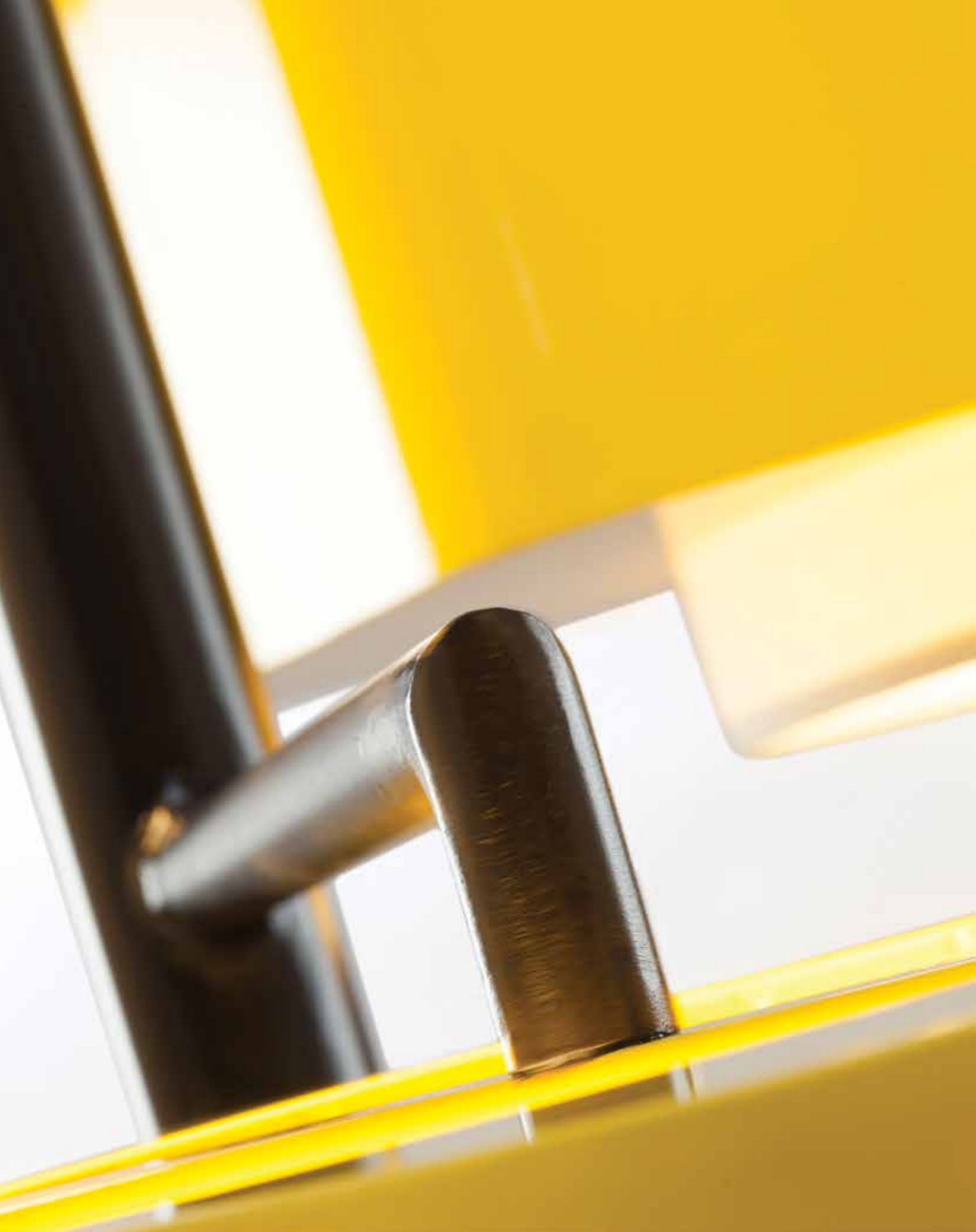

\*design by Cláudia Melo



01



02



03



04

## carousel I

suspension lamp  
ø: 38 in  
h: 34 in  
lacquered metal and 3 cotton shades  
● energy saving bulbs E27 / 3x23W

candeeiro de suspensão  
ø: 97 cm  
a: 86 cm  
metal lacado e 3 abajures de algodão  
● lâmpada económica E27 / 3x23W





**Love Ceramic Tiles**  
 Von Hoff Architecture & Design and  
 Rita Glória project  
 Portugal

\*design by Cláudia Melo

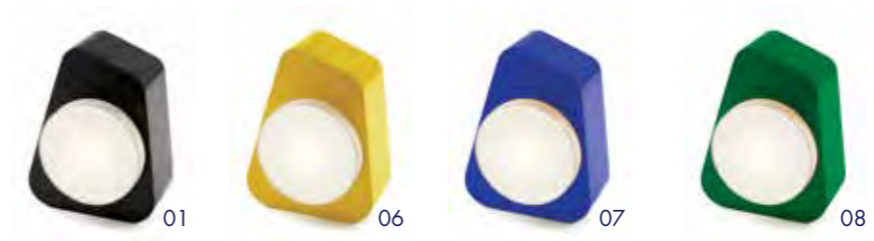
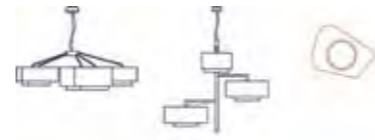

## carousel wall

wall lamp  
 w: 16 in  
 d: 7 in  
 h: 12 in  
 lacquered metal or brass/copper and  
 cotton shade  
 ● energy saving bulbs E27 / 1x20W

applique  
 l: 40 cm  
 p: 18 cm  
 a: 30 cm  
 metal lacado ou latão/cobre e abajur  
 de algodão  
 ● lâmpada económica E27 / 1x20W



## Junqueira Residence

Star is a lampshade collection made of polished brass. Our goal was to create a lamp filled with personality that could fit in a wide range of environments. Seducing, this asymmetrical floating structure, with its rich linen lampshade, is a sculptural piece that brings a touch of poetry to spaces. The unpredictable geometry gives the Star lamp many different facets, from each perspective that it is observed.

### Junqueira Residence

Roof Design Studio project

Portugal

\*design by Cláudia Melo



01



02

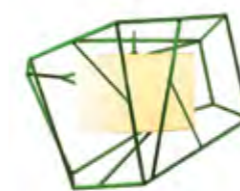

03

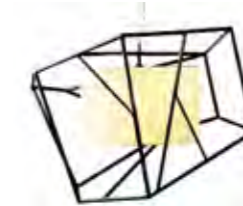

04

star

suspension lamp  
max w: 32 in  
max h: 28 in  
lacquered metal, brass or copper and  
linen shade  
● energy saving bulbs E27 / 1x23W

candeeiro de suspensão  
l max: 80 cm  
a max: 70 cm  
metal lacado, latão ou cobre e abajur  
de linho  
● lâmpada económica E27 / 1x23W





\*design by Cláudia Melo



01



02



03



04

## star I

suspension lamp  
max w: 24 in  
max h: 20 in  
lacquered metal, brass or copper and  
linen shade  
● energy saving bulbs E27 / 1x23W

candeeiro de suspensão  
l max: 60 cm  
a max: 50 cm  
metal lacado, latão ou cobre e abajur  
de linho  
● lâmpada económica E27 / 1x23W





\*design by Cláudia Melo



01

star  
053

## star II

suspension lamp  
max w: 18 in  
max h: 28 in  
lacquered metal, brass or copper and  
linen shade  
● energy saving bulbs E27 / 1x23W

candeeiro de suspensão  
l max: 45 cm  
a max: 72 cm  
metal lacado, latão ou cobre e abajur  
de linho  
● lâmpada económica E27 / 1x23W



02



03



04



05





**Boca restaurant**

Viterbo Interior Design project

Singapore

\*design by Cláudia Melo



01

star  
055

**star III**

suspension lamp  
 max w: 14 in  
 max h: 21 in  
 lacquered metal, brass or copper and  
 linen shade  
 ● energy saving bulbs E27 / 1x23W

candeeiro de suspensão  
 l max: 35 cm  
 a max: 53 cm  
 metal lacado, latão ou cobre e abajur  
 de linho  
 ● lâmpada económica E27 / 1x23W

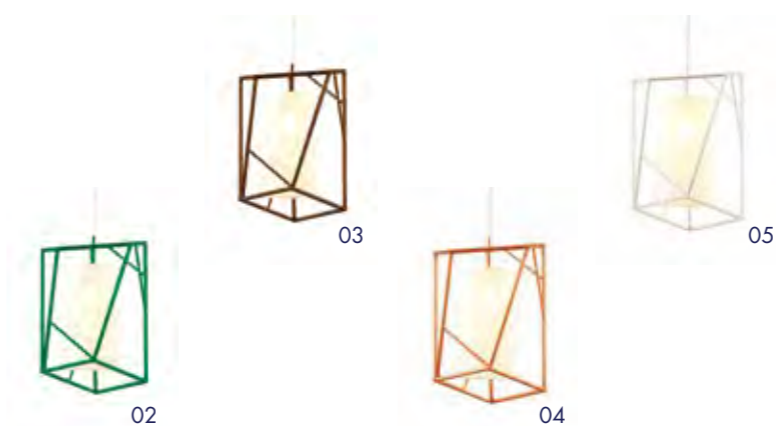

02

03

04

05





## Star collection

Light as made of pure lines. With no standard base, Star table lamp seems light as a feather. While one travels through space and sees it in different perspectives, its shape changes. It never looks the same. It's the perfect balance between elegance and irreverence.

\*design by Cláudia Melo



01



02



03



04



05

## star table

table lamp  
max w: 13 in  
max h: 29 in  
lacquered metal, brass or copper and  
linen shade  
● energy saving bulbs E27 / 1x15W

candeeiro de mesa  
l max: 33 cm  
a max: 72 cm  
metal lacado, latão ou cobre e abajur  
de linho  
● lâmpada económica E27 / 1x15W





**Private house**  
 Roof Design Studio project  
 Portugal

\*design by Cláudia Melo



01



03



04



05

## star floor

floor lamp  
 max w: 18 in  
 max h: 67 in  
 lacquered metal, brass or copper and  
 linen shade  
 ● energy saving bulbs E27 / 1x23W

candeeiro de chão  
 l max: 45 cm  
 a max: 170 cm  
 metal lacado, latão ou cobre e abajur de  
 linho  
 ● lâmpada económica E27 / 1x23W





**Groenendael Hotel**  
Coralie Michiels project  
Holland

## Groenendael Hôtel



Featured at Groenendael Hôtel, Star wall lamps are the perfect fit for this modern and sleek space. With its faceted golden jewel look, balanced with its purity of lines, Star wall lamps enrich the space.

\*design by Cláudia Melo



01



## star wall

wall lamp  
max w: 11 in  
max d: 8 in  
max h: 20 in  
lacquered metal, brass or copper and  
linen shade  
● energy saving bulbs E14 / 1x20W

applique  
l max: 28 cm  
p max: 20 cm  
a max: 51 cm  
metal lacado, latão ou cobre e abajur de  
linho  
● lâmpada económica E14 / 1x20W





iSight Partners offices  
Roof Design Studio project  
Holland

**iSight  
Partners**

Up lamps combine classic with original style. A rhythmic lacquered metal mesh makes these pieces surface textured and the light results soft and comfortable filtered by the cotton lampshade. At iSight Partners office in Amsterdam, a space with a cosy irreverent feeling is accomplished with these lamps.

\*design by Cláudia Melo

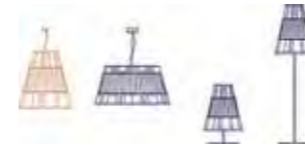

01



02



03



04



05

up

suspension lamp  
ø: 22 in  
h: 28 in

lacquered metal and optional metal,  
brass or copper ring and cotton shade  
● energy saving bulbs E27 / 1x23W

candeeiro de suspensão  
ø: 55 cm  
a: 72 cm

metal lacado e aro em metal, latão ou  
cobre opcional e abajur de algodão  
● lâmpada económica E27 / 1x23W

up  
063





\*design by Cláudia Melo



01



02



04



03



05

up I

suspension lamp  
 ø: 27 in  
 h: 15 in

lacquered metal and optional metal,  
 brass or copper ring and cotton shade  
 ● energy saving bulbs E27 / 1x23W

candeeiro de suspensão  
 ø: 68 cm  
 a: 39 cm

metal lacado e aro em metal, latão ou  
 cobre opcional e abajur de algodão  
 ● lâmpada económica E27 / 1x23W

up  
 065





**Private house**  
Roof Design Studio project  
Portugal

\*design by Cláudia Melo



01

## up table

table lamp  
ø: 17 in  
h: 28 in

lacquered metal and optional metal,  
brass or copper ring and cotton shade  
● energy saving bulbs E27 / 1x15W

candeeiro de mesa  
ø: 44 cm  
a: 72 cm

metal lacado e aro em metal, latão, ou  
cobre opcional e abajur de algodão  
● lâmpada económica E27 / 1x15W



02



03



04





**Private house**  
Roof Design Studio project  
Portugal

\*design by Cláudia Melo

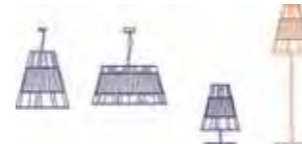

01



02



03



04

## up floor

floor lamp  
ø: 19 in  
h: 67 in  
lacquered metal and optional metal,  
brass or copper ring and cotton shade  
● energy saving bulbs E27 / 1x23W

candeeiro de chão  
ø: 47 cm  
a: 170 cm  
metal lacado e aro em metal, latão ou  
cobre opcional e abajur de algodão  
● lâmpada económica E27 / 1x23W





**Le Belmont restaurant**  
France

\*design by Cláudia Melo



01

circus

071

## circus

suspension lamp  
 ø: 22 in  
 h: 29 in  
 lacquered metal, copper or brass and  
 5 cotton shades  
 ● energy saving bulbs E27 / 5x23W

candeeiro de suspensão  
 ø: 56 cm  
 a: 73 cm  
 metal lacado, cobre ou latão e 5 abajures  
 de algodão  
 ● lâmpada económica E27 / 5x23W



02



03



04



05





**OYSHO stores**  
 Contemporain Studio project  
 Spain/ Portugal

\*design by Cláudia Melo



01



02



03



04

## circus I

suspension lamp  
 ø: 22 in  
 h: 15 in  
 lacquered metal, copper or brass and  
 5 cotton shades  
 energy saving bulbs E27 / 5x23W

candeeiro de suspensão  
 ø: 56 cm  
 a: 38 cm  
 metal lacado, cobre ou latão e 5 abajures  
 de algodão  
 lâmpada económica E27 / 5x23W





## Le Berry

Circus lamps round and linear design result in powerful and elegant pieces. Extremely balanced and handmade with extreme care, Circus lamps have a strong classy feeling. Seen here at Le Berry restaurant, they are a plus on lighting and sophistication.



Le Berry  
France

\*design by Cláudia Melo



01

circus  
075

## circus II

suspension lamp  
 ø: 26 in  
 h: 13 in  
 lacquered metal, copper or brass and  
 5 cotton shades  
 ● energy saving bulbs E27 / 5x23W



02



03



04

candeeiro de suspensão  
 ø: 65 cm  
 a: 34 cm  
 metal lacado, cobre ou latão e 5 abajures  
 de algodão  
 ● lâmpada económica E27 / 5x23W



\*design by Cláudia Melo



01



02



03



04

## circus III

suspension lamp  
ø: 12 in  
h: 26 in  
lacquered metal, copper or brass and  
cotton shade  
● energy saving bulbs E27 / 1x20W

candeeiro de suspensão  
ø: 30 cm  
a: 66 cm  
metal lacado, cobre ou latão e abajur de  
algodão  
● lâmpada económica E27 / 1x20W





**Private house**  
Roof Design Studio project  
Portugal

\*design by Cláudia Melo

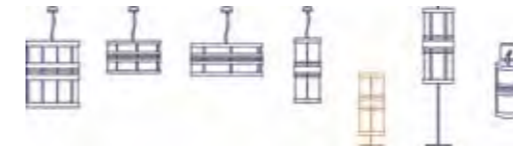

01



## circus table

table lamp  
ø: 12 in  
h: 30 in  
lacquered metal, copper or brass and  
cotton shade  
● energy saving bulbs E27 / 1x15W

candeeiro de mesa  
ø: 30 cm  
a: 76 cm  
metal lacado, cobre ou latão e abajur  
de algodão  
● lâmpada económica E27 / 1x15W

circus  
**079**



# London Home

Circus floor lamp is an uncommon lamp, as it is a column of light with its wide illuminated area. It distributes light in a large area, providing soft, comfortable lighting that spreads throughout the space. At this modern and art filled London home, it shines with its elegant presence.



**Private house**  
Lewis and Company project  
United Kingdom

\*design by Cláudia Melo



01



02



03



04



05

## circus floor

floor lamp  
ø: 14 in  
h: 67 in  
lacquered metal, copper or brass and  
6 cotton shades  
● energy saving bulbs E27 / 6x15W

candeeiro de chão  
ø: 35 cm  
a: 170 cm  
metal lacado, cobre ou latão e 6 abajures  
de algodão  
● lâmpada económica E27 / 6x15W





**Love Ceramic Tiles**  
 Von Hoff Architecture & Design and  
 Rita Glória project  
 Lisboa, Portugal

\*design by Cláudia Melo

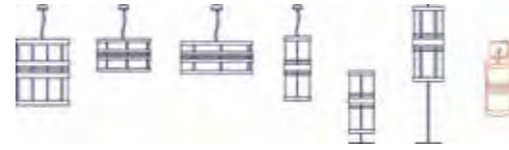

01

## circus wall



02



03



04

wall lamp  
 ø: 11 in  
 d: 12 in  
 h: 24 in  
 lacquered metal, copper or brass and  
 cotton shade  
 ● energy saving bulbs E14 / 1x20W

applique  
 ø: 27 cm  
 p: 30 cm  
 a: 62 cm  
 metal lacado, cobre ou latão e abajur  
 de algodão  
 ● lâmpada económica E14 / 1x20W





**Antemare hotel**  
 Patricia Galdón Studio project  
 Spain

\*design by Cláudia Melo



01

spider  
**085**



**spider**

suspension lamp  
 ø: 28 in  
 h: 14 in  
 lacquered metal  
 ● energy saving bulbs E27 / 1x23W

candeeiro de suspensão  
 ø: 70 cm  
 a: 35 cm  
 metal lacado  
 ● lâmpada económica E27 / 1x23W



\*design by Cláudia Melo



01

## Spider collection

Spider collection is a complete lighting range, from suspension to wall lamps, which design plays with shape and transparency. The different suspension sizes available result in very different pieces, not only regarding sizes but also formats. The wall, floor and table lamps are surprising, shapes inspired in a section of the suspension lamp, adding a complete new concept to this collection.



## spider I

suspension lamp  
ø: 20 in  
h: 28 in  
lacquered metal

● energy saving bulbs E27 / 1x23W

candeeiro de suspensão  
ø: 52 cm  
a: 70 cm  
metal lacado

● lâmpada económica E27 / 1x23W



\*design by Cláudia Melo



01



## spider II

suspension lamp  
ø: 28 in  
h: 39 in  
lacquered metal

● energy saving bulbs E27 / 1x23W

candeeiro de suspensão  
ø: 70 cm  
a: 100 cm  
metal lacado

● lâmpada económica E27 / 1x23W





**Roof Design Studio**  
Portugal

\*design by Cláudia Melo



spider  
**091**

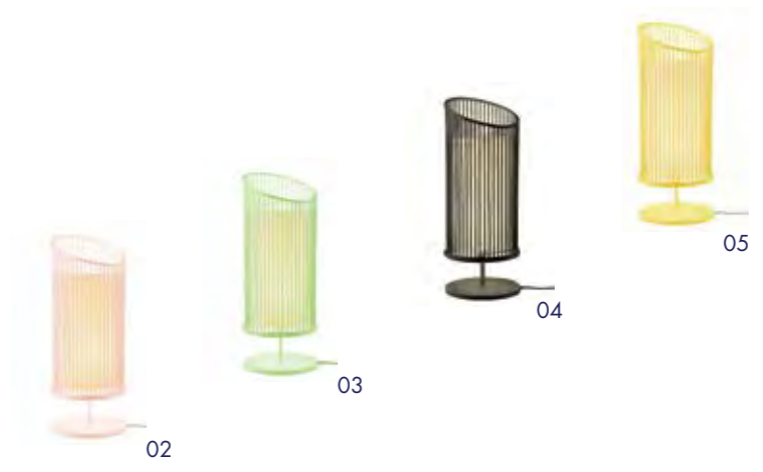

### spider table

table lamp  
ø: 9 in  
h: 20 in  
lacquered metal and cotton shade  
● energy saving bulbs E27 / 1x15W

candeeiro de mesa  
ø: 24 cm  
a: 60 cm  
metal lacado e abajur de algodão  
● lâmpada económica E27 / 1x15W





**Private house**  
 Roof Design Studio project  
 Portugal

\*design by Cláudia Melo



01

spider  
**093**

## spider floor

floor lamp  
 ø: 9 in  
 h: 55 in  
 lacquered metal and cotton shade  
 energy saving bulbs E27 / 2x23W

candeeiro de chão  
 ø: 24 cm  
 a: 140 cm  
 metal lacado e abajur de algodão  
 lâmpada económica E27 / 2x23W



02



03



04



05





**Maulu hotel**  
Russia

\*design by Cláudia Melo



01

spider  
**095**

## spider wall



wall lamp  
 w: 10 in  
 d: 6 in  
 h: 20 in  
 lacquered metal and/or brass and cotton shade  
 ● energy saving bulbs E14 / 1x15W  
  
 applique  
 l: 25 cm  
 p: 15 cm  
 a: 50 cm  
 metal lacado e/ou latão e abajur de algodão  
 ● lâmpada económica E14 / 1x15W





\*design by Cláudia Melo

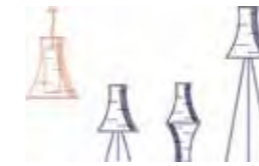

01



02



03



04



05

## extrude

suspension lamp  
ø: 24 in  
h: 28 in  
lacquered metal and cotton shade  
● energy saving bulbs E27 / 1x23W

candeeiro de suspensão  
ø: 60 cm  
a: 70 cm  
metal lacado e abajur de algodão  
● lâmpada económica E27 / 1x23W



\*design by Cláudia Melo



01



02



03



04

## extrude table

table lamp  
ø: 14 in  
h: 28 in  
lacquered metal  
● energy saving bulbs E27 / 1x15W

candeeiro de mesa  
ø: 35 cm  
a: 70 cm  
metal lacado  
● lâmpada económica E27 / 1x15W





Roof Design Studio  
Portugal

\*design by Cláudia Melo



01



02



03



04



05

## extrude table I

table lamp  
ø: 13 in  
h: 30 in  
lacquered metal

● energy saving bulbs E27 / 1x15W

candeeiro de mesa  
ø: 34 cm  
a: 75 cm  
metal lacado

● lâmpada económica E27 / 1x15W



# Junqueira Residence

\*design by Cláudia Melo

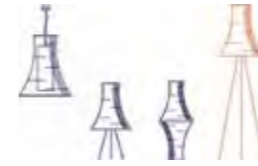

01

Extrude lamps are joyful and irreverent, with their uncommon shapes and bases. Here featured at a Lisbon residence, the Extrude floor shows its tripod base, which makes this lamp streamlined and original.

**Private house**  
Roof Design Studio project  
Portugal



02



03



04



05

## extrude floor

floor lamp  
ø: 20 in  
h: 69 in  
lacquered metal  
● energy saving bulbs E27 / 1x23W

candeeiro de chão  
ø: 50 cm  
a: 175 cm  
metal lacado  
● lâmpada económica E27 / 1x23W





**Antemare hotel**  
 Patricia Galdón Studio project  
 Spain

\*design by Cláudia Melo



01



## revolution

suspension lamp  
 ø: 22 in  
 h: 28 in  
 lacquered metal  
 ● energy saving bulbs E27 / 1x23W

candeeiro de suspensão  
 ø: 55 cm  
 a: 70 cm  
 metal lacado  
 ● lâmpada económica E27 / 1x23W





**Antemare hotel**  
 Patricia Galdón Studio project  
 Spain

\*design by Cláudia Melo



01



02

03

04

## expand

suspension lamp  
 ø: 20 in  
 h: 28 in  
 lacquered metal  
 ● energy saving bulbs E27 / 1x23W

candeeiro de suspensão  
 ø: 50 cm  
 a: 70 cm  
 metal lacado  
 ● lâmpada económica E27 / 1x23W



\*design by Cláudia Melo



01



02



03



04

## cage

suspension lamp  
ø: 28 in  
h: 28 in  
lacquered metal, brass or copper and cotton shade  
● energy saving bulbs E27 / 1x23W

candeeiro de suspensão  
ø: 70 cm  
a: 70 cm  
metal lacado, latão ou cobre e abajur de algodão  
● lâmpada económica E27 / 1x23W





**iSight Partners offices**  
 Roof Design Studio project  
 Holland

\*design by Cláudia Melo

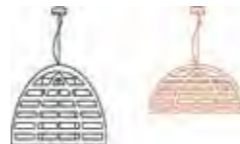

01

cage



## cage I

suspension lamp  
 ø: 28 in  
 h: 14 in  
 lacquered metal, brass or copper and  
 cotton shade  
 ● energy saving bulbs E27 / 1x23W

candeeiro de suspensão  
 ø: 70 cm  
 a: 35 cm  
 metal lacado, latão ou cobre e abajur de  
 algodão  
 ● lâmpada económica E27 / 1x23W



02



03



04





**Coriander Leaf restaurant**  
 URBNarc project  
 Singapore

\*design by Cláudia Melo



01



02



04



03



05

## new spider

suspension lamp  
 ø: 28 in  
 h: 14 in  
 lacquered metal and brass, copper or metal ring  
 ● energy saving bulbs E27 / 1x23W

candeeiro de suspensão  
 ø: 70 cm  
 a: 35 cm  
 metal lacado e aro em latão, cobre ou metal  
 ● lâmpada económica E27 / 1x23W



\*design by Cláudia Melo



01

## Antemare Hotel

Born form the Spider collection, New Spider is enriched with a lacquered metal, brass or copper detail at its base. The resulting combination of different colors and materials transforms these lamps in pieces with their own personality. Here they are featured at the entrance of Antemare Hotel in Sitges.

### Antemare hotel

Patricia Galdón Studio project

Spain



02



03



04



05

## new spider I

suspension lamp  
ø: 20 in  
h: 28 in  
lacquered metal and brass, copper or metal ring  
● energy saving bulbs E27 / 1x23W

candeeiro de suspensão  
ø: 52 cm  
a: 70 cm  
metal lacado e aro em latão, cobre ou metal  
● lâmpada económica E27 / 1x23W





## Coriander Leaf

New Spider are unique lamps that bring light movements into spaces. The light projects through the revolving structural elements, in a dance between light and shade. Scenographic, they bring character to spaces, as seen here at restaurant Coriander Leaf in Singapore.

### Coriander Leaf restaurant

URBNarc project

Singapore

\*design by Cláudia Melo



01

## new spider

suspension lamp  
 ø: 28 in  
 h: 39 in

lacquered metal and brass, copper or metal ring  
 ● energy saving bulbs E27 / 1x23W

candeeiro de suspensão  
 ø: 70 cm  
 a: 100 cm

metal lacado e aro em latão, cobre ou metal  
 ● lâmpada económica E27 / 1x23W



02



03



04



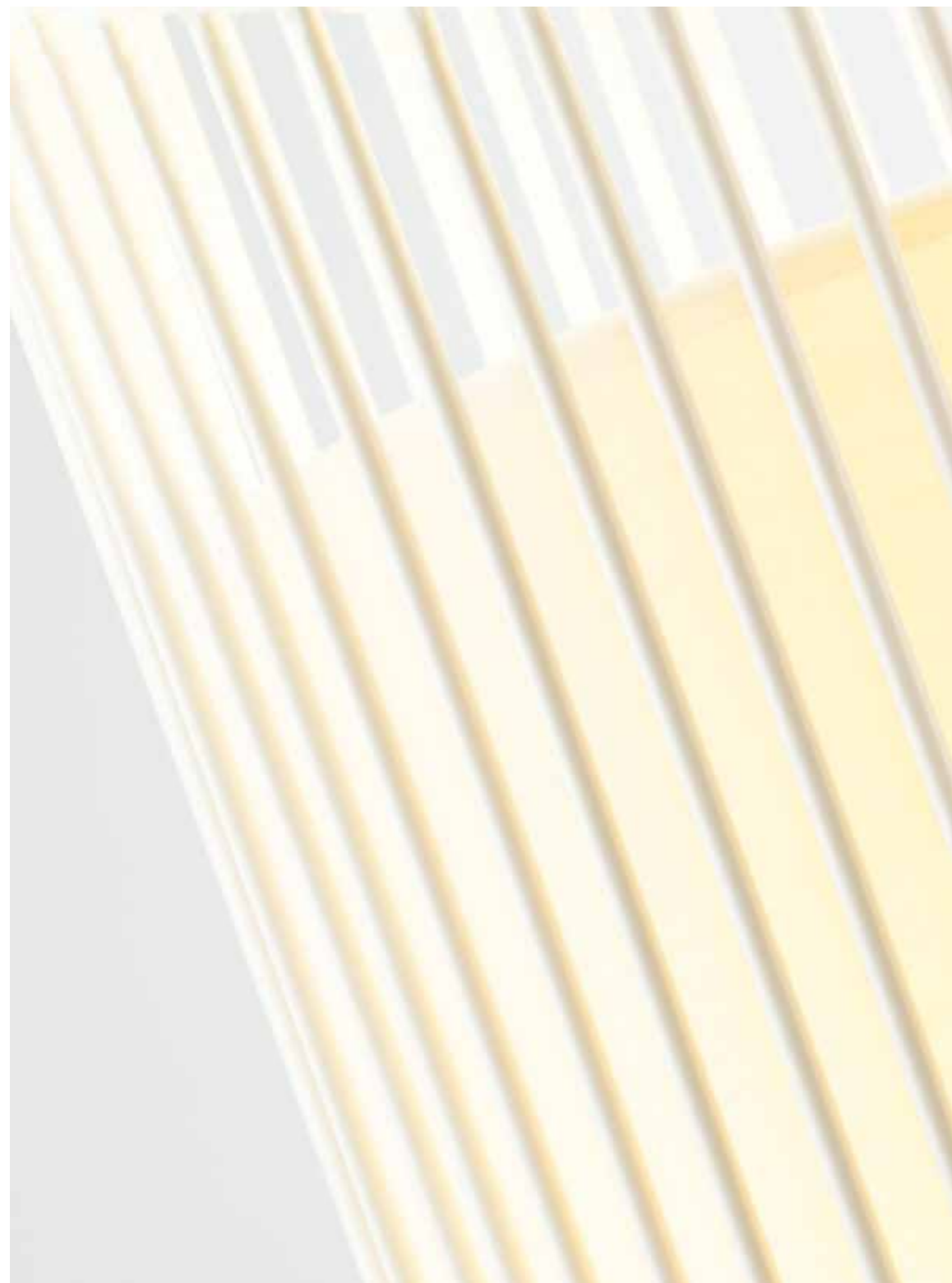

\*design by Cláudia Melo



01



## new spider table

table lamp  
ø: 28 in  
h: 14 in  
lacquered metal and brass, copper or metal  
ring and cotton shade  
● energy saving bulbs E27 / 1x15W

candeeiro de mesa  
ø: 70 cm  
a: 35 cm  
metal lacado e aro em latão, cobre ou metal  
e abajur de algodão  
● lâmpada económica E27 / 1x15W



**Meet our**  
**Lighting Collection**



## suspension

<b>magnolia</b>	 metal custom colors ø65 x 68 cm	<b>magnolia I</b>	 metal custom colors ø65 x 47 cm	<b>magnolia II</b>	 metal custom colors ø27 x 59 cm	<b>magnolia III</b>	 metal custom colors ø31 x 42 cm	<b>jules</b>	 metal custom colors ø63 x 72 cm	<b>jules I</b>	 metal custom colors ø63 x 57 cm
<b>jules II</b>	 metal custom colors ø30 x 64 cm	<b>jules II</b>	 metal custom colors ø38 x 44 cm	<b>comb</b>	 metal custom colors ø74 x 60 cm	<b>comb I</b>	 metal custom colors ø75 x 35 cm	<b>carousel</b>	 metal custom colors ø105 x 40 cm	<b>carousel I</b>	 metal custom colors ø97 x 86 cm
<b>star</b>	 metal custom colors ø80 x 70 cm	<b>star I</b>	 metal custom colors ø60 x 50 cm	<b>star II</b>	 metal custom colors ø45 x 72 cm	<b>star III</b>	 metal custom colors ø35 x 53 cm	<b>up</b>	 metal custom colors ø55 x 72 cm	<b>up I</b>	 metal custom colors ø68 x 39 cm
<b>circus</b>	 metal custom colors ø56 x 73 cm	<b>circus I</b>	 metal custom colors ø56 x 38 cm	<b>circus II</b>	 metal custom colors ø65 x 34 cm	<b>circus III</b>	 metal custom colors ø30 x 66 cm	<b>spider</b>	 metal custom colors ø70 x 35 cm	<b>spider I</b>	 metal custom colors ø52 x 70 cm
<b>spider II</b>	 metal custom colors ø70 x 100 cm	<b>extrude</b>	 metal custom colors ø60 x 70 cm	<b>revolution</b>	 metal custom colors ø55 x 70 cm	<b>expand</b>	 metal custom colors ø50 x 70 cm	<b>cage</b>	 metal custom colors ø70 x 70 cm	<b>cage I</b>	 metal custom colors ø70 x 35 cm
<b>new spider</b>	 metal custom colors ø70 x 35 cm	<b>new spider I</b>	 metal custom colors ø52 x 70 cm	<b>new spider II</b>	 metal custom colors ø70 x 100 cm						

## table

<b>magnolia table</b>	 metal custom colors ø32 x 63 cm	<b>jules table</b>	 metal custom colors ø30 x 63 cm	<b>star table</b>	 metal custom colors ø33 x 72 cm	<b>up table</b>	 metal custom colors ø44 x 72 cm	<b>circus table</b>	 metal custom colors ø30 x 76 cm	<b>spider table</b>	 metal custom colors ø24 x 60 cm
<b>extrude table</b>	 metal custom colors ø35 x 70 cm	<b>extrude I table</b>	 metal custom colors ø34 x 75 cm	<b>new spider table</b>	 metal custom colors ø24 x 60 cm						

## floor

<b>magnolia floor</b>	 metal custom colors ø37 x 170 cm	<b>jules floor</b>	 metal custom colors ø38 x 177 cm	<b>comb floor</b>	 metal custom colors ø54 x 175 cm	<b>star floor</b>	 metal custom colors ø45 x 170 cm	<b>up floor</b>	 metal custom colors ø47 x 170 cm	<b>circus floor</b>	 metal custom colors ø35 x 170 cm
<b>extrude floor</b>	 metal custom colors ø50 x 175 cm	<b>spider floor</b>	 metal custom colors ø24 x 140 cm								

## wall

<b>magnolia wall</b>	 metal custom colors 30 x 13 x 56 cm	<b>jules wall</b>	 metal custom colors 40 x 23 x 40 cm	<b>comb wall</b>	 metal custom colors 37 x 13 x 34 cm	<b>carousel wall</b>	 metal custom colors 30 x 18 x 40 cm	<b>star wall</b>	 metal custom colors 28 x 20 x 51 cm	<b>circus wall</b>	 metal custom colors 27 x 30 x 62 cm
<b>spider wall</b>	 metal custom colors 25 x 15 x 50 cm										



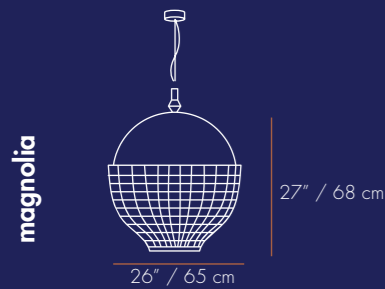

magnolia

27" / 68 cm

26" / 65 cm

230V / 50Hz  
 ● E27/1x23W CFL 19 lb | 9 kg  
 30x30x30 in  
 120V / 60Hz  
 ● E26/1x18W CFL 75x75x75 cm  
 0,42 m<sup>3</sup>  
 Cable  
 59" / 1,5m

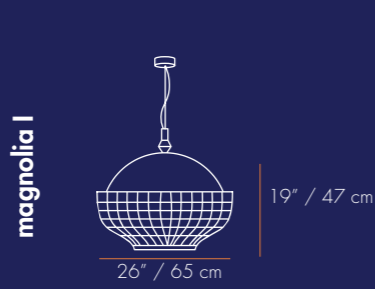

magnolia I

19" / 47 cm

26" / 65 cm

230V / 50Hz  
 ● E27/1x23W CFL 19 lb | 9 kg  
 25x25x20 in  
 120V / 60Hz  
 ● E26/1x18W CFL 65x65x50 cm  
 0,21 m<sup>3</sup>  
 Cable  
 59" / 1,5m

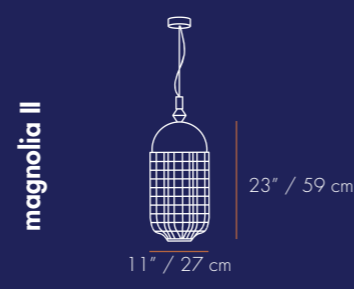

magnolia II

23" / 59 cm

11" / 27 cm

230V / 50Hz  
 ● E27/1x23W CFL 13 lb | 6 kg  
 13x13x30 in  
 120V / 60Hz  
 ● E26/1x18W CFL 34x34x80 cm  
 0,09 m<sup>3</sup>  
 Cable  
 59" / 1,5m

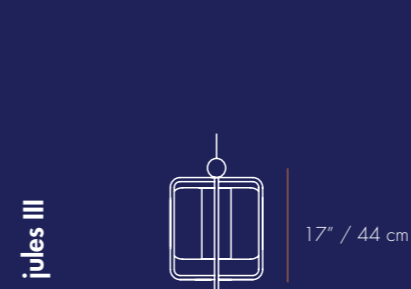

jules III

17" / 44 cm

15" / 38 cm

230V / 50Hz  
 ● E27/1x23W CFL 11 lb | 5 kg  
 13x13x18 in  
 120V / 60Hz  
 ● E26/1x18W CFL 34x34x45 cm  
 0,05 m<sup>3</sup>  
 Cable  
 59" / 1,5m

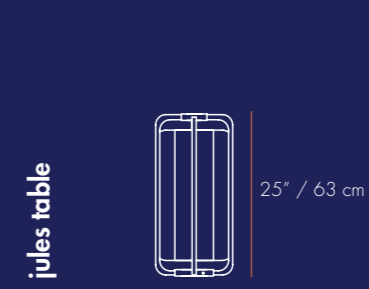

jules table

25" / 63 cm

12" / 30 cm

230V / 50Hz  
 ● E27/1x15W CFL 17 lb | 8 kg  
 13x13x30 in  
 120V / 60Hz  
 ● E26/1x13W CFL 34x34x80 cm  
 0,09 m<sup>3</sup>

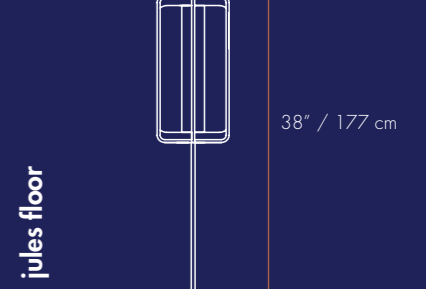

jules floor

38" / 177 cm

15" / 38 cm

230V / 50Hz  
 ● E27/1x23W CFL 26 lb | 12 kg  
 18x18x71 in  
 120V / 60Hz  
 ● E26/1x18W CFL 46x46x180 cm  
 0,38 m<sup>3</sup>

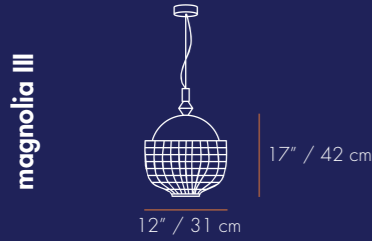

magnolia III

17" / 42 cm

12" / 31 cm

230V / 50Hz  
 ● E27/1x20W CFL 11 lb | 5 kg  
 13x13x18 in  
 120V / 60Hz  
 ● E26/1x15W CFL 34x34x45 cm  
 0,05 m<sup>3</sup>  
 Cable  
 59" / 1,5m

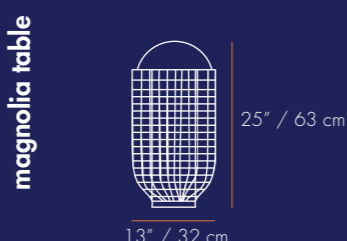

magnolia table

25" / 63 cm

13" / 32 cm

230V / 50Hz  
 ● E27/1x15W CFL 17 lb | 8 kg  
 13x13x30 in  
 120V / 60Hz  
 ● E26/1x13W CFL 34x34x80 cm  
 0,09 m<sup>3</sup>

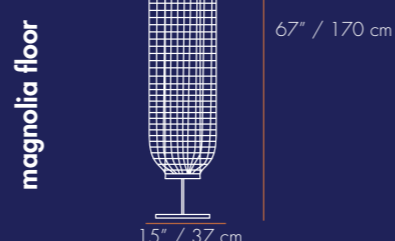

magnolia floor

67" / 170 cm

15" / 37 cm

230V / 50Hz  
 ● E27/2x23W CFL 26 lb | 12 kg  
 18x18x71 in  
 120V / 60Hz  
 ● E26/2x18W CFL 46x46x180 cm  
 0,38 m<sup>3</sup>



jules wall

16" / 40 cm

9" / 23cm

230V / 50Hz  
 ● E14/1x20W CFL 8 lb | 4 kg  
 18x18x12 in  
 120V / 60Hz  
 ● E12/1x15W CFL 46x46x30 cm  
 0,05 m<sup>3</sup>

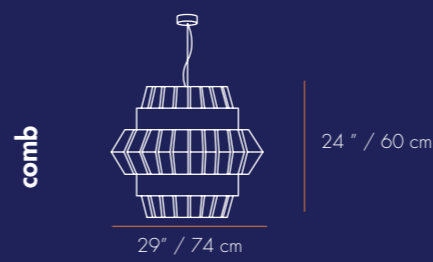

comb

24" / 60 cm

29" / 74 cm

230V / 50Hz  
 ● E27/1x23W CFL 35 lb | 16 kg  
 30x30x30 in  
 120V / 60Hz  
 ● E26/1x18W CFL 75x75x75 cm  
 0,42 m<sup>3</sup>  
 Cable  
 59" / 1,5m

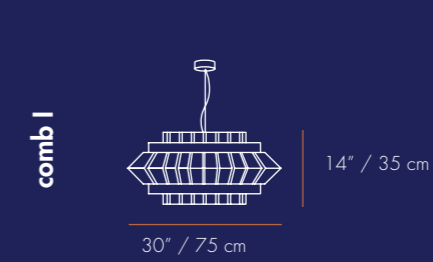

comb I

14" / 35 cm

30" / 75 cm

230V / 50Hz  
 ● E27/1x23W CFL 35 lb | 16 kg  
 30x30x16 in  
 120V / 60Hz  
 ● E26/1x18W CFL 75x75x40 cm  
 0,23 m<sup>3</sup>  
 Cable  
 59" / 1,5m

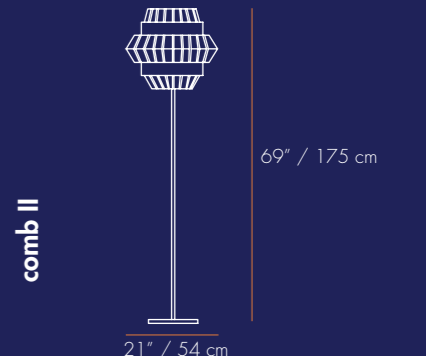

comb II

69" / 175 cm

21" / 54 cm

230V / 50Hz  
 ● E27/1x23W CFL 30 lb | 14 kg  
 24x24x71 in  
 120V / 60Hz  
 ● E26/1x18W CFL 60x60x180 cm  
 0,65 m<sup>3</sup>

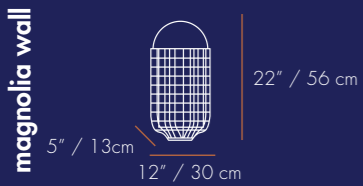

magnolia wall

22" / 56 cm

5" / 13cm

12" / 30 cm

230V / 50Hz  
 ● E14/1x20W CFL 8 lb | 4 kg  
 14x10x22 in  
 120V / 60Hz  
 ● E12/1x15W CFL 35x25x56 cm  
 0,05 m<sup>3</sup>

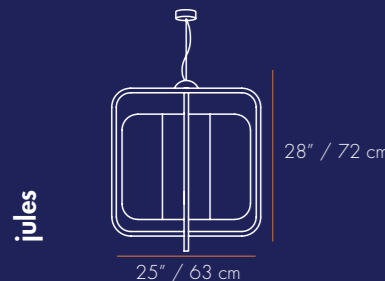

jules

28" / 72 cm

25" / 63 cm

230V / 50Hz  
 ● E27/1x23W CFL 19 lb | 9 kg  
 30x30x30 in  
 120V / 60Hz  
 ● E26/1x18W CFL 75x75x75 cm  
 0,42 m<sup>3</sup>  
 Cable  
 59" / 1,5m

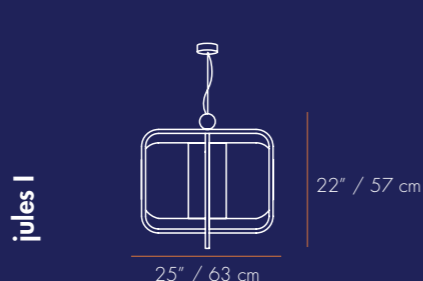

jules I

22" / 57 cm

25" / 63 cm

230V / 50Hz  
 ● E27/1x23W CFL 19 lb | 9 kg  
 25x25x20 in  
 120V / 60Hz  
 ● E26/1x18W CFL 65x65x50 cm  
 0,21 m<sup>3</sup>  
 Cable  
 59" / 1,5m

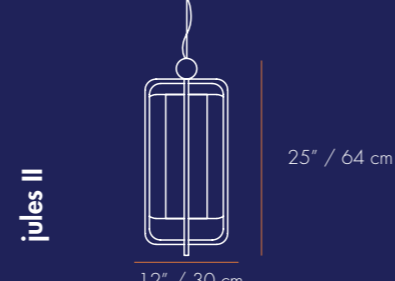

jules II

25" / 64 cm

12" / 30 cm

230V / 50Hz  
 ● E27/1x23W CFL 13 lb | 6 kg  
 13x13x30 in  
 120V / 60Hz  
 ● E26/1x18W CFL 34x34x80 cm  
 0,09 m<sup>3</sup>  
 Cable  
 59" / 1,5m

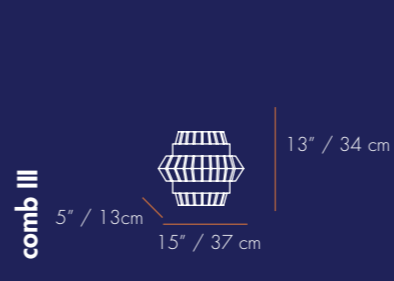

comb III

13" / 34 cm

5" / 13cm

15" / 37 cm

230V / 50Hz  
 ● E14/1x20W CFL 11 lb | 5 kg  
 14x10x22 in  
 120V / 60Hz  
 ● E12/1x15W CFL 35x25x56 cm  
 0,05 m<sup>3</sup>





carousel

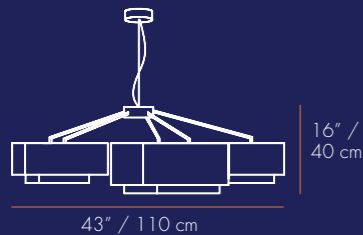

230V / 50Hz 44 lb | 20 kg  
 E27/3/5 x23W CFL 43x43x18 in  
 120V / 60Hz 110x110x45 cm  
 E26/3/5x18W CFL 0,55 m<sup>3</sup>  
 Cable 59" / 1,5m

carousel I

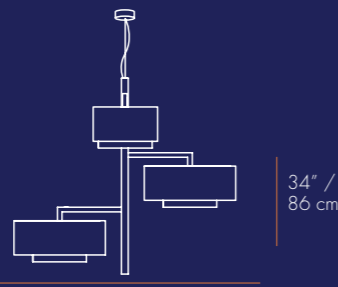

230V / 50Hz 44 lb | 20 kg  
 E27/3x23W CFL 43x43x18 in  
 120V / 60Hz 110x110x45 cm  
 E26/3x18W CFL 0,55 m<sup>3</sup>  
 Cable 59" / 1,5m

carousel wall

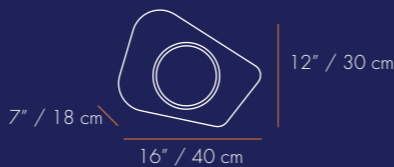

230V / 50Hz 11 lb | 5 kg  
 E27/1x20W CFL 14x10x22 in  
 120V / 60Hz 35x25x56 cm  
 E26/1x15W CFL 0,05 m<sup>3</sup>  
 Cable 59" / 1,5m

up

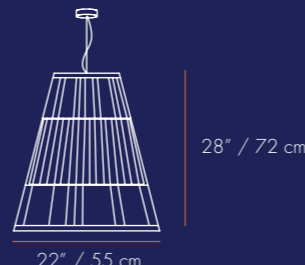

230V / 50Hz 19 lb | 9 kg  
 E27/1x23W CFL 30x30x30 in  
 120V / 60Hz 75x75x75 cm  
 E26/1x18W CFL 0,42 m<sup>3</sup>  
 Cable 59" / 1,5m

up I

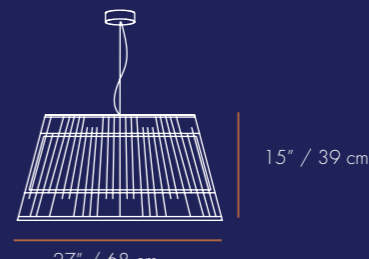

230V / 50Hz 34 lb | 15 kg  
 E27/1x23W CFL 30x30x17 in  
 120V / 60Hz 75x75x45 cm  
 E26/1x18W CFL 0,25 m<sup>3</sup>  
 Cable 59" / 1,5m

up table

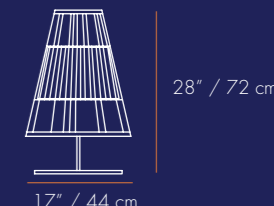

230V / 50Hz 19 lb | 9 kg  
 E27/1x15W CFL 18x18x32 in  
 120V / 60Hz 46x46x80 cm  
 E26/1x13W CFL 0,16 m<sup>3</sup>  
 Cable 59" / 1,5m

star

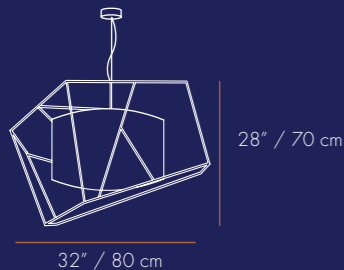

230V / 50Hz 13 lb | 6 kg  
 E27/1x23W CFL 30x30x30 in  
 120V / 60Hz 75x75x75 cm  
 E26/1x18W CFL 0,42 m<sup>3</sup>  
 Cable 59" / 1,5m

star I

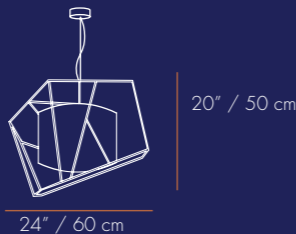

230V / 50Hz 13 lb | 6 kg  
 E27/1x23W CFL 25x25x25 in  
 120V / 60Hz 65x65x65 cm  
 E26/1x18W CFL 0,28 m<sup>3</sup>  
 Cable 59" / 1,5m

star II

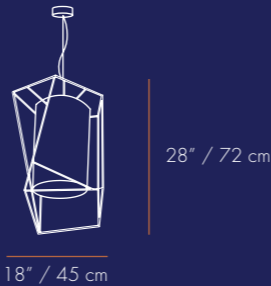

230V / 50Hz 11 lb | 5 kg  
 E27/1x23W CFL 18x18x31 in  
 120V / 60Hz 46x46x80 cm  
 E26/1x18W CFL 0,17 m<sup>3</sup>  
 Cable 59" / 1,5m

up floor

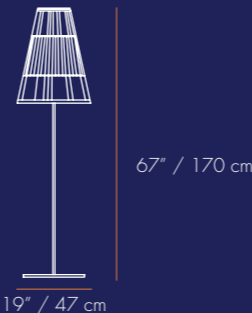

230V / 50Hz 27 lb | 12 kg  
 E27/1x23W CFL 20x20x70 in  
 120V / 60Hz 52x52x180 cm  
 E26/1x18W CFL 0,49 m<sup>3</sup>  
 Cable 59" / 1,5m

star III

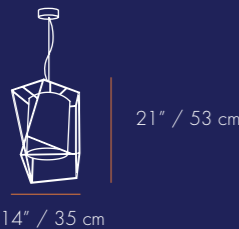

230V / 50Hz 8 lb | 4 kg  
 E27/1x20W CFL 18x18x22 in  
 120V / 60Hz 46x46x55 cm  
 E26/1x15W CFL 0,18 m<sup>3</sup>  
 Cable 59" / 1,5m

star table



230V / 50Hz 9 lb | 4 kg  
 E27/1x15W CFL 18x18x30 in  
 120V / 60Hz 46x46x75 cm  
 E26/1x13W CFL 0,16 m<sup>3</sup>  
 Cable 59" / 1,5m

star floor

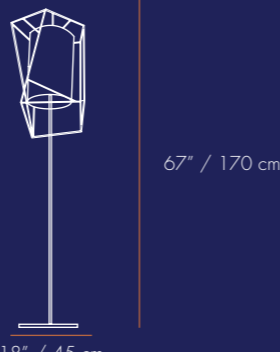

230V / 50Hz 19 lb | 9 kg  
 E27/1x23W CFL 18x18x71 in  
 120V / 60Hz 46x46x180 cm  
 E26/1x18W CFL 0,38 m<sup>3</sup>  
 Cable 59" / 1,5m

circus

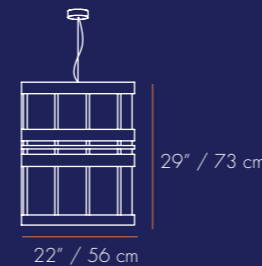

230V / 50Hz 35 lb | 14 kg  
 E27/5x23W CFL 30x30x30 in  
 120V / 60Hz 75x75x75 cm  
 E26/5x18W CFL 0,42 m<sup>3</sup>  
 Cable 59" / 1,5m

circus I

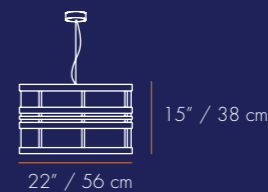

230V / 50Hz 28 lb | 13 kg  
 E27/5x23W CFL 30x30x17 in  
 120V / 60Hz 75x75x45 cm  
 E26/5x18W CFL 0,25 m<sup>3</sup>  
 Cable 59" / 1,5m

circus II

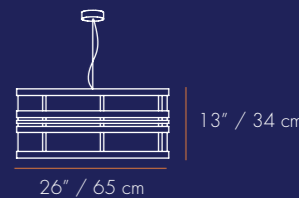

230V / 50Hz 30 lb | 14 kg  
 E27/5x23W CFL 30x30x16 in  
 120V / 60Hz 75x75x40 cm  
 E26/5x18W CFL 0,23 m<sup>3</sup>  
 Cable 59" / 1,5m

star wall



230V / 50Hz 6 lb | 3 kg  
 E14/1x20W CFL 14x10x22 in  
 120V / 60Hz 35x25x56 cm  
 E12/1x15W CFL 0,05 m<sup>3</sup>  
 Cable 59" / 1,5m

circus III

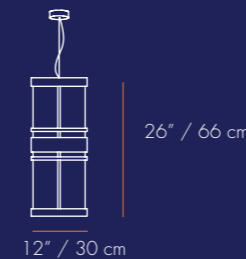

230V / 50Hz 17 lb | 8 kg  
 E27/1x20W CFL 13x13x30 in  
 120V / 60Hz 34x34x80 cm  
 E26/1x18W CFL 0,09 m<sup>3</sup>  
 Cable 59" / 1,5m

circus table

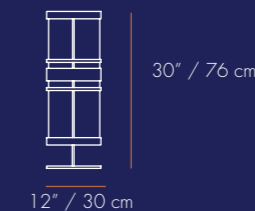

230V / 50Hz 17 lb | 8 kg  
 E27/1x15W CFL 13x13x30 in  
 120V / 60Hz 34x34x80 cm  
 E26/1x13W CFL 0,09 m<sup>3</sup>  
 Cable 59" / 1,5m

circus floor

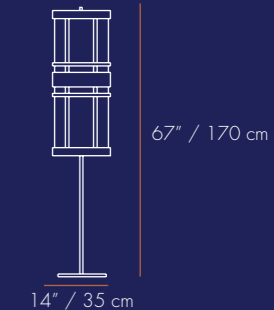

230V / 50Hz 37 lb | 17 kg  
 E27/6x15W CFL 18x18x71 in  
 120V / 60Hz 46x46x180 cm  
 E26/6x13W CFL 0,38 m<sup>3</sup>  
 Cable 59" / 1,5m



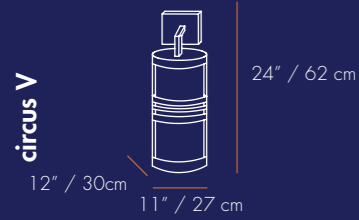

circus V

24" / 62 cm  
12" / 30cm  
11" / 27 cm  
230V / 50Hz 17 lb | 8 kg  
E27/1x20W CFL 13x13x30 in  
120V / 60Hz 34x34x80 cm  
E26/1x18W CFL 0,09 m<sup>3</sup>  
CE

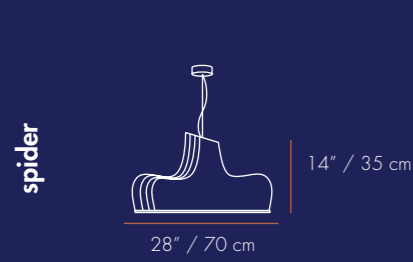

spider

14" / 35 cm  
28" / 70 cm  
230V / 50Hz 17 lb | 8 kg  
E27/1x23W CFL 30x30x16 in  
120V / 60Hz 75x75x40 cm  
E26/1x18W CFL 0,26 m<sup>3</sup>  
Cable 59" / 1,5m  
CE

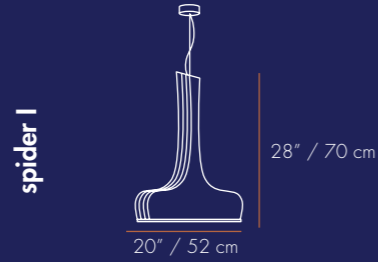

spider I

28" / 70 cm  
20" / 52 cm  
230V / 50Hz 19 lb | 9 kg  
E27/1x23W CFL 30x30x30 in  
120V / 60Hz 75x75x75 cm  
E26/1x18W CFL 0,42 m<sup>3</sup>  
Cable 59" / 1,5m  
CE

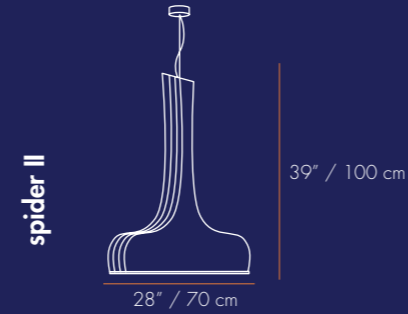

spider II

39" / 100 cm  
28" / 70 cm  
230V / 50Hz 26 lb | 12 kg  
E27/1x23W CFL 30x30x41 in  
120V / 60Hz 75x75x105 cm  
E26/1x18W CFL 0,59 m<sup>3</sup>  
Cable 59" / 1,5m  
CE

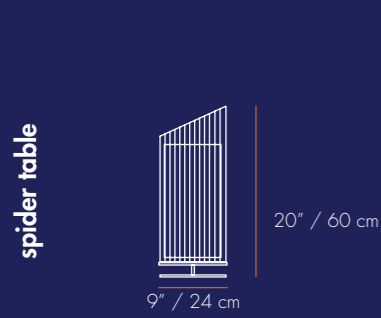

spider table

20" / 60 cm  
9" / 24 cm  
230V / 50Hz 15 lb | 7 kg  
E27/1x15W CFL 14x10x22 in  
120V / 60Hz 34x34x80 cm  
E26/1x13W CFL 0,09 m<sup>3</sup>  
CE

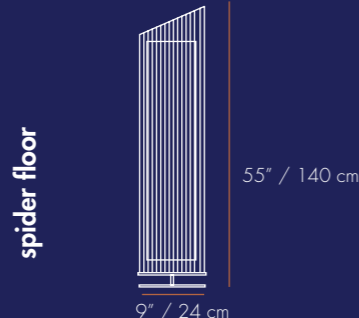

spider floor

55" / 140 cm  
9" / 24 cm  
230V / 50Hz 26 lb | 12 kg  
E27/2x23W CFL 18x18x59 in  
120V / 60Hz 46x46x150 cm  
E26/2x18W CFL 0,38 m<sup>3</sup>  
CE

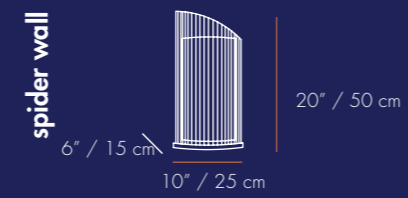

spider wall

20" / 50 cm  
6" / 15 cm  
10" / 25 cm  
230V / 50Hz 11 lb | 5 kg  
E14/1x20W CFL 14x10x22 in  
120V / 60Hz 35x25x57 cm  
E12/1x15W CFL 0,05 m<sup>3</sup>  
CE

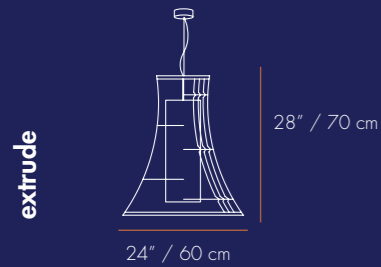

extrude

28" / 70 cm  
24" / 60 cm  
230V / 50Hz 19 lb | 9 kg  
E27/1x23W CFL 30x30x30 in  
120V / 60Hz 75x75x75 cm  
E26/1x18W CFL 0,42 m<sup>3</sup>  
Cable 59" / 1,5m  
CE

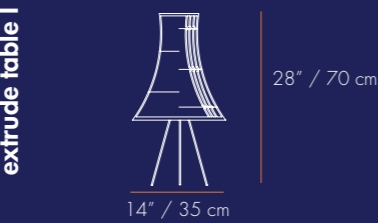

extrude table I

28" / 70 cm  
14" / 35 cm  
230V / 50Hz 13 lb | 6 kg  
E27/1x15W CFL 13x13x30 in  
120V / 60Hz 34x34x80 cm  
E26/1x13W CFL 0,09 m<sup>3</sup>  
CE

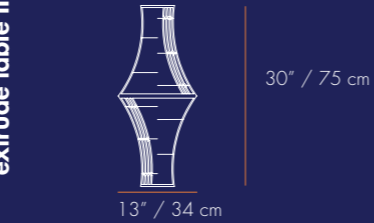

extrude table II

30" / 75 cm  
13" / 34 cm  
230V / 50Hz 15 lb | 7 kg  
E27/1x15W CFL 13x13x30 in  
120V / 60Hz 34x34x80 cm  
E26/1x13W CFL 0,09 m<sup>3</sup>  
CE

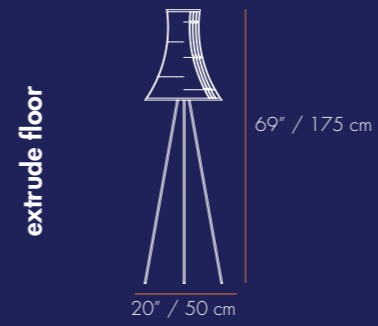

extrude floor

69" / 175 cm  
20" / 50 cm  
230V / 50Hz 26 lb | 12 kg  
E27/1x23W CFL 20x20x70 in  
120V / 60Hz 56x56x180 cm  
E26/1x18W CFL 0,57 m<sup>3</sup>  
CE

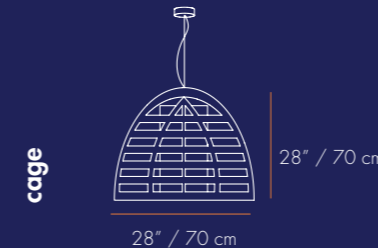

cage

28" / 70 cm  
28" / 70 cm  
230V / 50Hz 50 lb | 22 kg  
E27/1x23W CFL 30x30x30 in  
120V / 60Hz 75x75x75 cm  
E26/1x18W CFL 0,42 m<sup>3</sup>  
Cable 59" / 1,5m  
CE

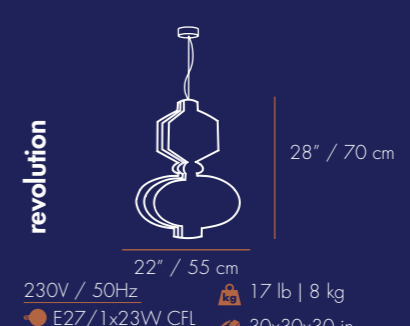

revolution

28" / 70 cm  
22" / 55 cm  
230V / 50Hz 17 lb | 8 kg  
E27/1x23W CFL 30x30x30 in  
120V / 60Hz 75x75x75 cm  
E26/1x18W CFL 0,42 m<sup>3</sup>  
Cable 59" / 1,5m  
CE



cage I

14" / 35 cm  
28" / 70 cm  
230V / 50Hz 26 lb | 12 kg  
E27/1x23 W CFL 30x30x16 in  
120V / 60Hz 75x75x40 cm  
E26/1x18W CFL 0,23 m<sup>3</sup>  
Cable 59" / 1,5m  
CE

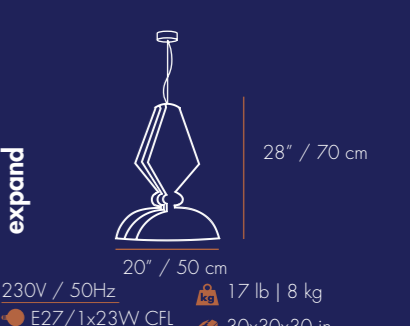

expand

28" / 70 cm  
20" / 50 cm  
230V / 50Hz 17 lb | 8 kg  
E27/1x23W CFL 30x30x30 in  
120V / 60Hz 75x75x75 cm  
E26/1x18W CFL 0,42 m<sup>3</sup>  
Cable 59" / 1,5m  
CE

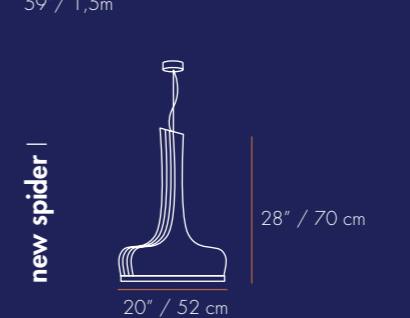

new spider I

28" / 70 cm  
20" / 52 cm  
230V / 50Hz 19 lb | 9 kg  
E27/1x23W CFL 30x30x30 in  
120V / 60Hz 75x75x75 cm  
E26/1x18W CFL 0,42 m<sup>3</sup>  
Cable 59" / 1,5m  
CE

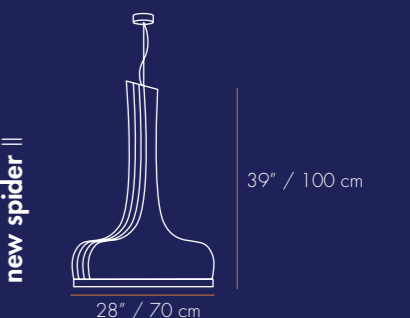

new spider II

39" / 100 cm  
28" / 70 cm  
230V / 50Hz 26 lb | 12 kg  
E27/1x23W CFL 30x30x41 in  
120V / 60Hz 75x75x105 cm  
E26/1x18W CFL 0,59 m<sup>3</sup>  
Cable 59" / 1,5m  
CE

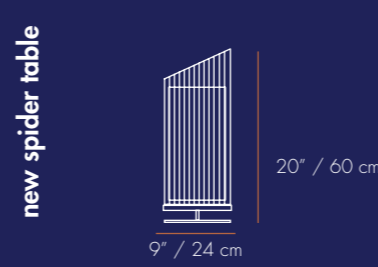

new spider table

20" / 60 cm  
9" / 24 cm  
230V / 50Hz 15 lb | 7 kg  
E27/1x15W CFL 14x10x22 in  
120V / 60Hz 34x34x80 cm  
E26/1x13W CFL 0,09 m<sup>3</sup>  
CE



## cup

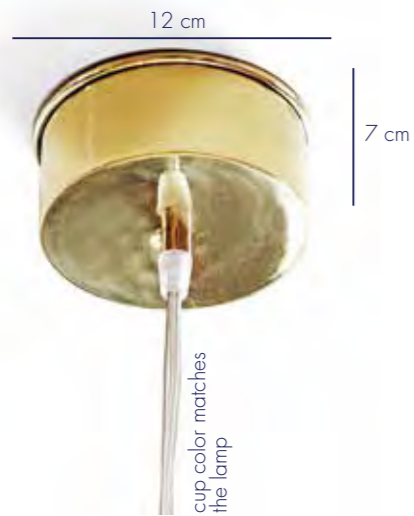

## CORDS

black textile cord

brown textile cord

red and blue textile cord\*

black and white textile cord\*

yellow textile cord\*

transparent rubber cord

\*on extra charge

## lamp shades



linen lamp shade



cotton lamp shade

more colors and shapes available on extra charge

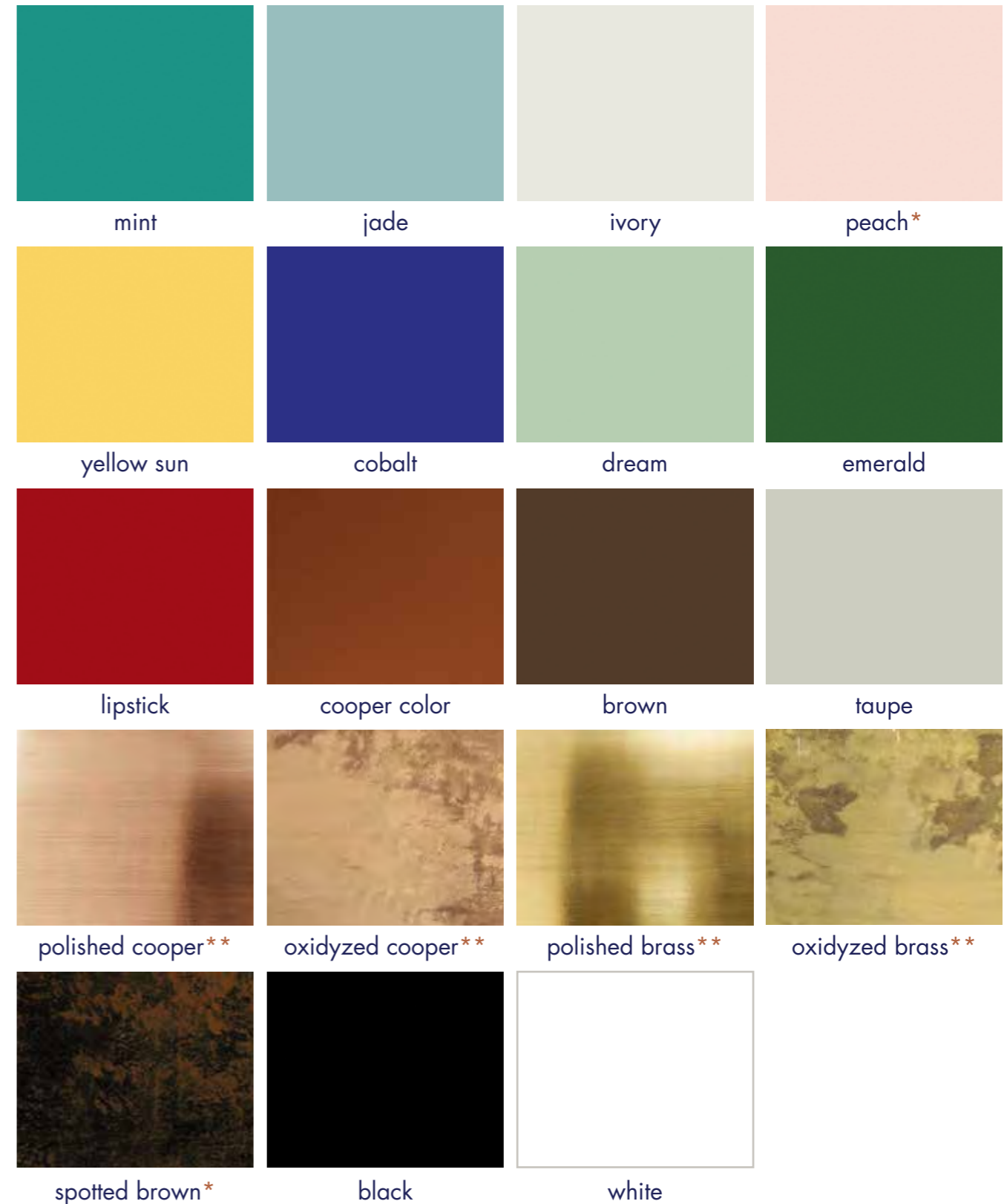

\*painted colors, not lacquered

\*\* this product is handmade. any small stain or roughness is a feature of the product, not a flaw. material not available for all models





by





